

601F/601F-M Product Application and Design Information

Introduction

The 601F Infra-red Flame detectors form part of the Series 600 range of plug in detectors for ceiling mounting. The detector plugs into the following bases:

- 5B 5" Universal Base
- 5BD 5" Diode Continuity Base
- 4B 4" Universal Base
- 4B-D 4" Diode Continuity Base

and is intended for two-wire operation with the majority of control equipment currently manufactured by the company.

The 601F-M is the Marine version of the 601F.

The 601F is solar blind.

The detector is only suitable for indoor use.

Operating Principle

Optical Characteristics

The 601F is designed to detect the infra-red radiation produced by flaming fires involving carbonaceous materials.

- Fig. 1(a) Fig. shows the spectrum of a typical fire of this type
- Fig. 1(b) the spectrum of the radiation of the sun and
- Fig. 1(c), that of a tungsten filament lamp.

It can be seen that there is a large peak in the flame output at wavelengths in the region of $4.45 \mu\text{m}$. This peak is a characteristic of carbonaceous flames and results from the formation of carbon dioxide in the flame. It will be seen also that the radiation from the sun and from the filament lamp is relatively low in this region.

In order to exploit these spectral characteristics, the 601F uses an optical filter which transmits infra-red between $4.38 \mu\text{m}$ and $4.56 \mu\text{m}$ (shown shaded in Fig. 1(a)). This bandwidth allows high sensitivity to flames with low sensitivity to other interfering sources.

Flicker Characteristics

It is observed that the radiation from a flame is not constant but varies with time. This flicker is present in all flames to a greater or lesser degree (including those resulting from high pressure gas jets) and can be used to give improved discrimination between flames and other sources of infra-red.

The 601F responds to flicker frequencies in the range of 1-10 Hz which provides high sensitivity to almost all types of accidental fire.

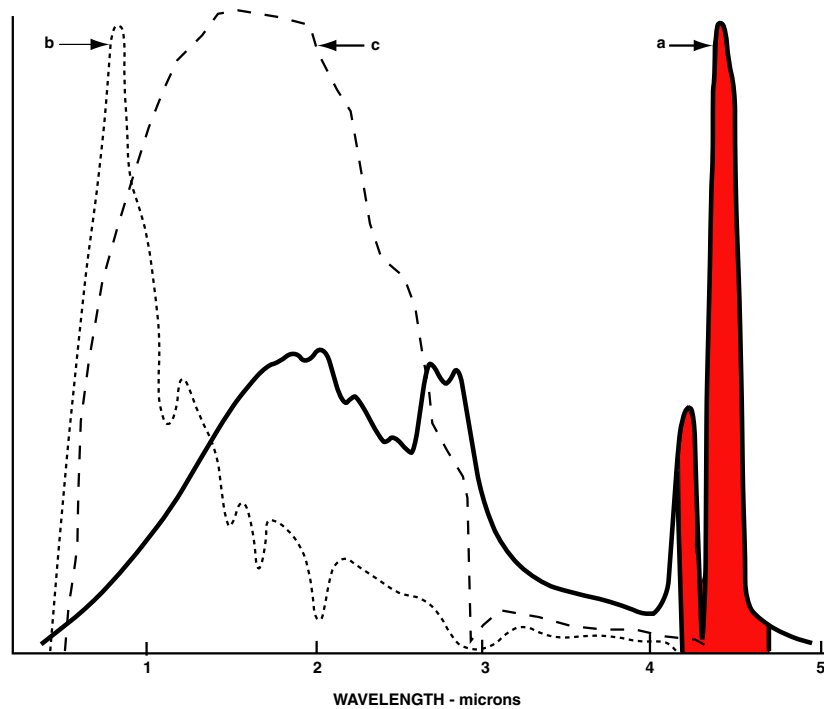

Fig. 1: Spectrums of:
 a) Typical Carbonaceous Fire
 b) Solar Radiation at Ground Level
 c) Tungsten Filament Lamp

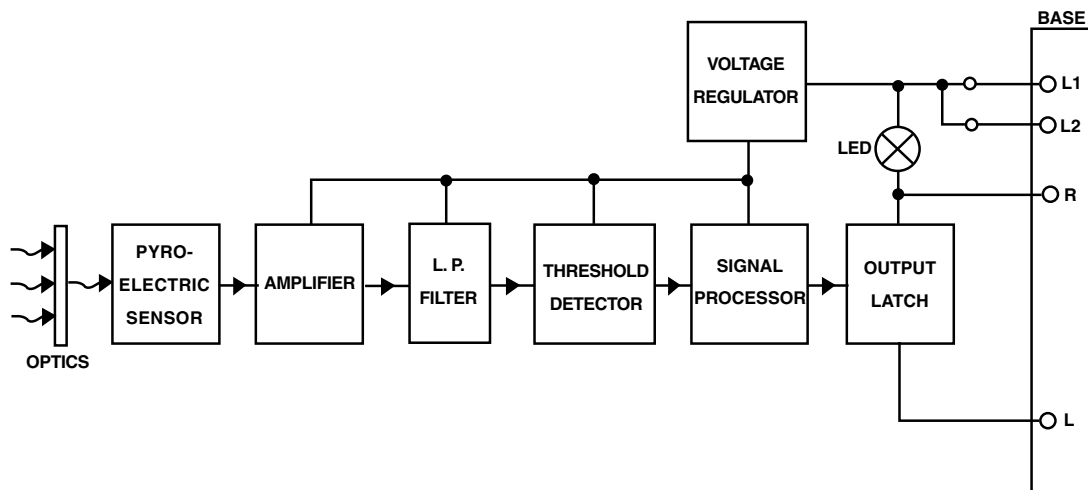

Fig. 2: Simplified Block Schematic Diagram of Detector

Circuit Operation

A simplified block schematic of the circuit is given in Fig. 2.

The infra-red radiation passing through the narrow-band filters falls on a pyroelectric sensor which responds to the flickering component of the radiation. The electrical

signal produced is amplified and filtered, to remove frequencies outside the required flicker region.

The threshold detector and signal processor evaluate the amplitude and frequency characteristics of the flicker. If the flicker signal is above the preset threshold for three seconds, the output latch is triggered to light the internal LED alarm indicator. The increased current

drawn from the line signals the alarm condition to the control unit.

All critical parts of the circuit are fed by an internal voltage regulator to make the sensitivity independent of supply over a wide range.

The facility for a remote LED indicator is available without the need for additional circuitry.

Two +ve terminals are provided to allow the monitoring of the circuit wiring through the detector.

Wiring

Loop cabling is connected to base terminals as follows:

Terminal	Connection
L	-VE IN/OUT
L1	+VE IN
L2	+VE OUT
R	Remote LED Drive

Table 1: Wiring Connections

Mechanical Construction

The major components of the detector are:

- Body Assembly
- Printed Circuit
- Outer Cover
- Sapphire lens

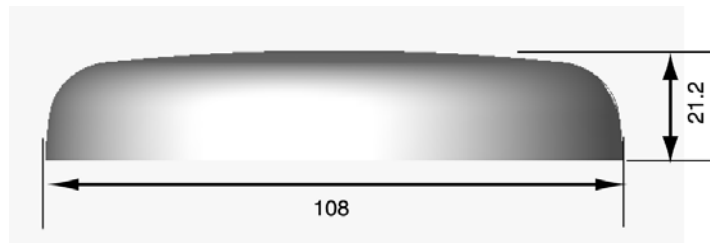

Fig. 3: Overall Dimensions of 601F Detector

Body Assembly

The body assembly consists of a plastic moulding to which are secured the four detector contacts which align with contacts in the base. The moulding incorporates securing features to retain the detector in the base.

The PCB is fitted into the base tray and then the outer cover with sapphire window is clipped onto the base, securing features securing the PCB.

Approvals

The 601F/601F-M meet all the requirements of EN 54: Part 10 as a Class 2 flame detector.

Technical Specification

Parameter	Value
Material: Body, Cover and Closure	FR110 'BAYBLEND' flame retardant.
Weight	74 g

Table 2: Technical Specification

The overall dimensions are shown in Fig. 3:

Environmental

Parameter	Value
Operating Temperature	-20 °C to +70 °C
Storage Temperature	-40 °C to +80 °C
Relative Humidity - Operational	90% RH continuous (non-condensing) and up to 99% RH intermittent (non-condensing)
Relative Humidity Storage	>40% RH and <70% RH
Shock	To EN54 Part 10
Vibration Impact	
Impact	
Corrosion	

Table 3: Environmental Conditions

i **Temperature Limitation**
 Operation below 0 °C is not recommended unless steps are taken to eliminate condensation and hence ice formation on the detector.

Electromagnetic Compatibility

The detector complies with the following:

Product family standard EN50130-4 in respect of:

- Conducted Disturbances,
- Radiated Immunity,
- Electrostatic Discharge,
- Fast Transients and
- Slow High Energy

EN61000-6-3 for Emissions

i **Compatibility Standards**
 The EMC standards fulfil the requirements of the European Directive for EMC (89/336/EEC).

Electrical Characteristics

Table 1 shows the electrical characteristics, these are taken at 25 °C with an operating voltage of 20 V unless otherwise specified. The alarm load presented to the controller by the detector is shown in Fig. 4.

Characteristics	Min.	Typ.	Max.	Unit
Operating Voltage (DC)	18		28	V
Quiescent Current	150	300	350	µA
Switch-on-Surge		850	1000	µA
Stabilisation Time			30	sec
Alarm Current	36 mA @ 18 V 42 mA @ 20 V 70.5 mA @ 31 V			mA
Holding Current			1	mA
Holding Voltage			5	V
Rest Time	1/2	1	2	sec
Remote LED Drive	via a 3.4 kΩ resistor			

Table 4: Electrical Characteristics

Performance Characteristics

Mode of Operation-Behaviour in Fire Tests

The "Circuit Operation" of the detector described on page 2 and the information given below is intended to supplement this basic description.

It has already been noted that the detector analyses the signal flicker frequency and produces an alarm if the level is above a preset threshold for three seconds. It is worth stressing that if the signal is below this threshold the detector will not respond even after a long time.

The level of the signal received depends on the size of the flame and its distance from the detector. For liquid fuels the level is almost proportional to the surface area of the burning liquid. For any type of fire, the signal level varies inversely with the square of the distance.

Fire tests are normally carried out using liquid fuels, burning in pans of known area. The sensitivity of a detector is then expressed as the distance at which a particular fire size can be detected.

It is important to think in terms of distance rather than time because of the burning characteristics of different fuels. Fig. 4 shows the typical response of two different fuels which ultimately produce the same signal level. The signal level given by n-heptane quickly reaches its maximum approximately six (6) seconds after ignition. Diesel, being less volatile, takes approximately sixty (60) seconds to reach equilibrium burning state and an alarm is given approximately fifty-five (55) seconds after ignition.

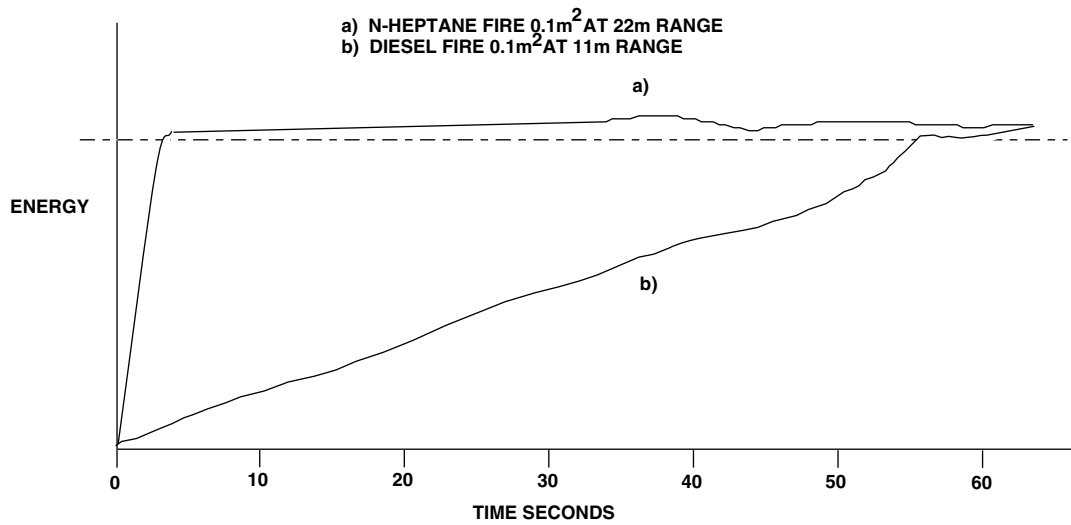

Fig. 4: Typical Response to Fires

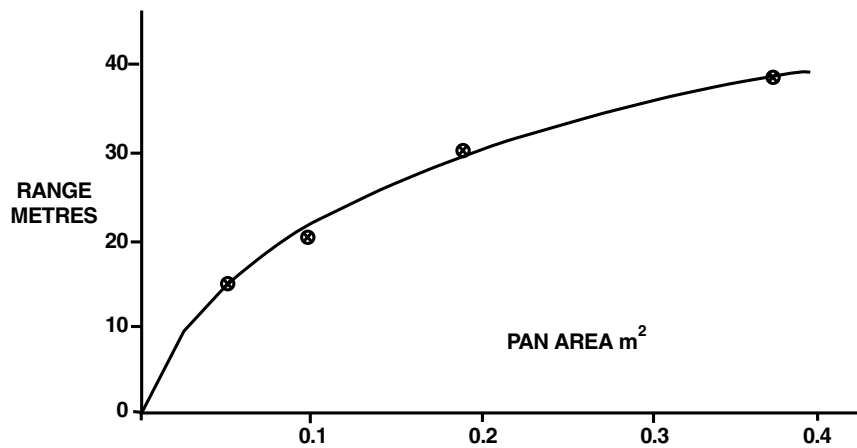

Fig. 5: Typical Detector Range vs Pan Area - n-heptane

The time taken by the fire to reach equilibrium depends on the initial temperature of the fuel. If diesel is pre-heated to a temperature above its flash point, then it behaves the same as n-heptane at 25 °C.

The “Fire Test Data” refers to fires, which have reached their equilibrium condition. The range specified is that obtained with the detector axis horizontal and with the fire on the detector axis.

Fire Test Data

N-Heptane

The most convenient fuel for fire tests is n-heptane since it is readily available and quickly reaches its equilibrium burning rate. The range figures specified in Fig. 5 relates to a n-heptane fire in a 0.1 m² pan on the main axis of the detector field of view.

The graph in Fig. 5 shows the typical detection ranges as a function of pan area for n-heptane fires. It will be seen that this curve is approximately a square law; that is to say that to obtain detection at twice the distance the pan area must be multiplied by four.

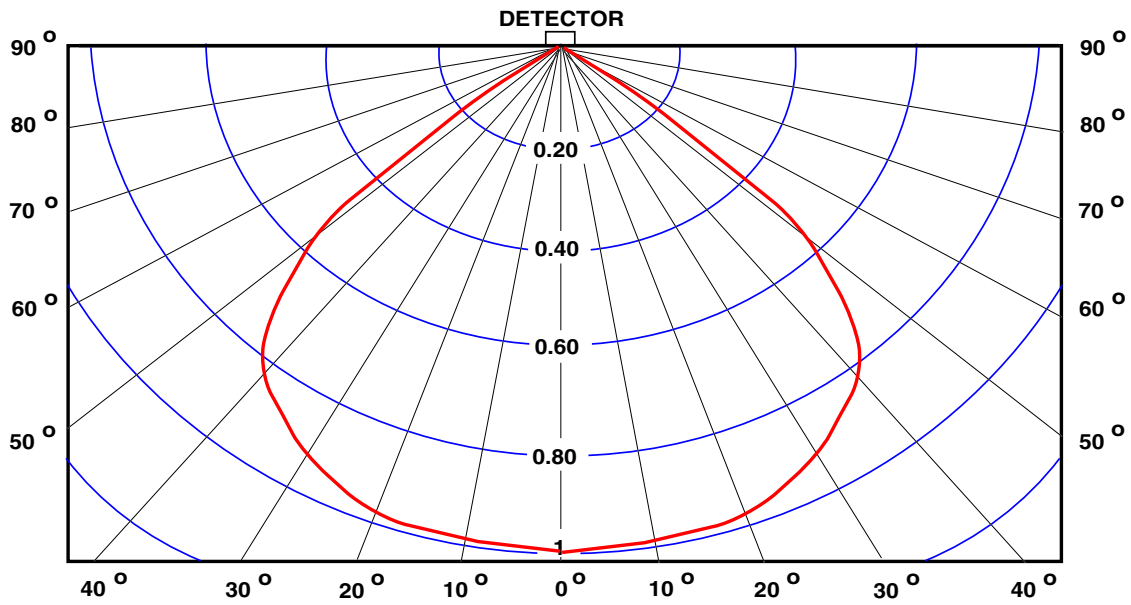

Fig. 6: Relative Range vs Angle of Incidence

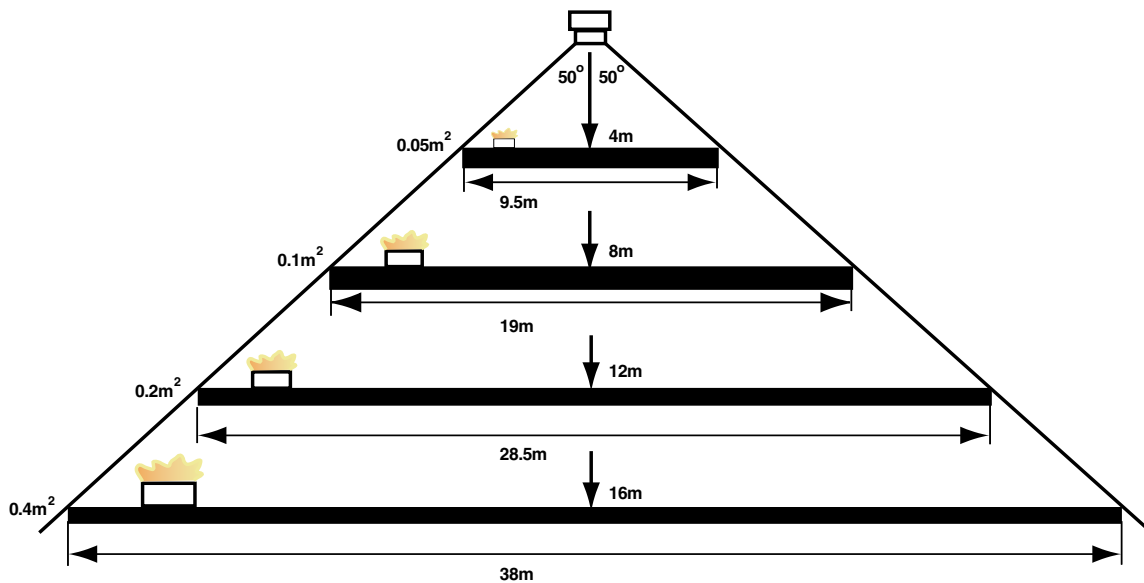

Fig. 7: Field of View

Other Liquid Hydrocarbons

Ranges achieved with other fuels burning in 0.1 m² pans are as follows:

Fuel	Range
Kerosene	15.5 m
Alcohol (I.M.S.)	13 m
Diesel oil	13 m
Ethylene glycol	15.5 m

Table 5: Fuel Burning Ranges

The typical detection range for other pan areas may be calculated using the square law relationship give in "Fire Test Data" on page 5.

Directional Sensitivity

The sensitivity of the 601F is at a maximum on the detector axis. The variation of range with angle of incidence is shown in Fig. 7.

Use of Fire Test Data

It has been explained in "Technical Specification" on page 3 that the sensitivity of the detector is specified in terms of its response to well-defined test fires. Tests are carried out using a 0.1 m² pan. Sensitivity to other pan areas is calculated from the square law relationship. That is to obtain detection at twice the distance, the pan area must be multiplied by four.

Accidental fires are rarely of a well-defined size. It is still possible, however, to calculate the response to a 'real' fire using the fire test data.

For example, a spillage fire involving a highly volatile liquid, e.g., n-heptane: will spread quickly from the point of ignition to cover the complete surface of the pool. Such a spillage would normally cover approximately 2 m².

Using the data for n-heptane fires and extrapolating to an area of 2 m², the 601F should respond at a distance of about 120 m.

If the spillage is of a less volatile material (e.g., diesel), the spread of the flame from the ignition point will be much slower, as will the detector response time.

Determining the Number of Detectors

The number of detectors required for a particular risk will depend on the area involved and the fire size at which detection is required. Large areas or small fires require large numbers of detectors.

As there are no agreed 'rules' for the application of flame detectors, the overall system sensitivity must be agreed between the designer and the end user. When agreement has been reached the system designer can

determine the area to be covered by each detector using the fire test data.

The detector is designed primarily for ceiling mounting with its axis vertically downwards. When used in this way it will cover a circular area at ground level, the diameters of the circle being proportional to the height. Under these conditions the effective sensitivity is that which is achieved at the edge of this circular area taking into account the slant range and the angle of incidence.



NOTICE: Hot Vibrating Body

Engines (and other hot vibrating bodies) can cause false alarms. This happens when the rising column of hot air above the engine has a wave motion from the vibration. This is interpreted by the detector as the flickering of a flame, which could cause false alarm.

To prevent this the detector should not be mounted above the engine. You should mount the detector so it points diagonally at the engine on a suitable bracket. Alternatively, mount the detector to a vertical wall pointing sideways at the engine.



NOTICE: Installation Guidance

The detectors should not be installed directly below or in close proximity to the watermist nozzles / sprinkler heads or where they will be directly effected by water when a release takes place.

Fig. 6 shows the effective sensitivity for n-heptane fires when used in this configuration. Sensitivity to other fuels can be determined from the data given in "Other Liquid Hydrocarbons" on page 6.



Field of View

Any object within the detector's field of view will cause a 'shadow' in the protected area. Small objects close to the detector can cause large shadows.

CPD Information

 0832
Tyco Safety Products Dunhams Lane Letchworth SG6 1BE UK 07 0832-CPD-0500
EN 54-10: 2002 + A1: 2005 Conventional Class 2 point type flame detector for use in fire detection and alarm systems in buildings 601F 601F-M (Marine) Application & Design 01C-02-D9 Installation Instructions 01C-02-I1 Service Instructions 01C-02-S1

Order Information

Product	Order Code
601F Infra-red Flame Detector	516.600.006
601F-M Infra-red Flame Detector (Marine)	516.600.007
5B 5" Universal Base	517.050.017
5BD 5" Conventional Diode Base	517.050.600
4B 4" Universal Base	517.050.041
4B-D 4" Diode Continuity Base	517.050.045

Table 6: Order Information