



Monitor
User Manual

About this Document

- This Document includes instructions for using and managing the Product. Pictures, charts, images and all other information hereinafter are for description and explanation only.
- The information contained in the Document is subject to change, without notice, due to firmware updates or other reasons. Please find the latest version of the Document at the Hikvision website (<https://www.hikvision.com>). Unless otherwise agreed, Hangzhou Hikvision Digital Technology Co., Ltd. or its affiliates (hereinafter referred to as "Hikvision") makes no warranties, express or implied.
- Please use the Document with the guidance and assistance of professionals trained in supporting the Product.

About this Product

This product can only enjoy the after-sales service support in the country or region where the purchase is made.

Acknowledgment of Intellectual Property Rights

- Hikvision owns the copyrights and/or patents related to the technology embodied in the Products described in this Document, which may include licenses obtained from third parties.
- Any part of the Document, including text, pictures, graphics, etc., belongs to Hikvision. No part of this Document may be excerpted, copied, translated, or modified in whole or in part by any means without written permission.
- **HIKVISION** and other Hikvision's trademarks and logos are the properties of Hikvision in various jurisdictions.
- Other trademarks and logos mentioned are the properties of their respective owners.
- **HDMI**™ The terms HDMI and HDMI High-Definition Multimedia Interface, and the HDMI Logo are trademarks or registered trademarks of HDMI Licensing Administrator, Inc. in the United States and other countries.

LEGAL DISCLAIMER

- TO THE MAXIMUM EXTENT PERMITTED BY APPLICABLE LAW, THIS DOCUMENT AND THE PRODUCT DESCRIBED, WITH ITS HARDWARE, SOFTWARE AND FIRMWARE, ARE PROVIDED "AS IS" AND "WITH ALL FAULTS AND ERRORS". HIKVISION MAKES NO WARRANTIES, EXPRESS OR IMPLIED, INCLUDING WITHOUT LIMITATION, MERCHANTABILITY, SATISFACTORY QUALITY, OR FITNESS FOR A PARTICULAR PURPOSE. THE USE OF THE PRODUCT BY YOU IS AT YOUR OWN RISK. IN NO EVENT WILL HIKVISION BE LIABLE TO YOU FOR ANY SPECIAL, CONSEQUENTIAL, INCIDENTAL, OR INDIRECT DAMAGES, INCLUDING, AMONG OTHERS, DAMAGES FOR LOSS OF BUSINESS PROFITS, BUSINESS INTERRUPTION, OR LOSS OF DATA, CORRUPTION OF SYSTEMS, OR LOSS OF DOCUMENTATION, WHETHER BASED ON BREACH OF CONTRACT, TORT (INCLUDING NEGLIGENCE), PRODUCT LIABILITY, OR OTHERWISE, IN CONNECTION WITH THE USE OF THE PRODUCT, EVEN IF HIKVISION HAS BEEN ADVISED OF THE POSSIBILITY OF SUCH DAMAGES OR LOSS.
- YOU ACKNOWLEDGE THAT THE NATURE OF THE INTERNET PROVIDES FOR INHERENT SECURITY RISKS, AND HIKVISION SHALL NOT TAKE ANY RESPONSIBILITIES FOR ABNORMAL OPERATION, PRIVACY LEAKAGE OR OTHER DAMAGES RESULTING FROM CYBER-ATTACK, HACKER ATTACK, VIRUS INFECTION, OR OTHER INTERNET SECURITY RISKS; HOWEVER, HIKVISION WILL PROVIDE TIMELY TECHNICAL SUPPORT IF REQUIRED.
- YOU AGREE TO USE THIS PRODUCT IN COMPLIANCE WITH ALL APPLICABLE LAWS, AND YOU ARE SOLELY

RESPONSIBLE FOR ENSURING THAT YOUR USE CONFORMS TO THE APPLICABLE LAW. ESPECIALLY, YOU ARE RESPONSIBLE, FOR USING THIS PRODUCT IN A MANNER THAT DOES NOT INFRINGE ON THE RIGHTS OF THIRD PARTIES, INCLUDING WITHOUT LIMITATION, RIGHTS OF PUBLICITY, INTELLECTUAL PROPERTY RIGHTS, OR DATA PROTECTION AND OTHER PRIVACY RIGHTS. YOU SHALL NOT USE THIS PRODUCT FOR ANY PROHIBITED END-USES, INCLUDING THE DEVELOPMENT OR PRODUCTION OF WEAPONS OF MASS DESTRUCTION, THE DEVELOPMENT OR PRODUCTION OF CHEMICAL OR BIOLOGICAL WEAPONS, ANY ACTIVITIES IN THE CONTEXT RELATED TO ANY NUCLEAR EXPLOSIVE OR UNSAFE NUCLEAR FUEL-CYCLE, OR IN SUPPORT OF HUMAN RIGHTS ABUSES.

- IN THE EVENT OF ANY CONFLICTS BETWEEN THIS DOCUMENT AND THE APPLICABLE LAW, THE LATTER PREVAILS.



© Hangzhou Hikvision Digital Technology Co., Ltd. All rights reserved.

Applicable Models

This manual is applicable to monitor.

Symbol Conventions

The symbols that may be found in this document are defined as follows.

Symbol	Description
 Note	Provides additional information to emphasize or supplement important points of the main text.
 Caution	Indicates a potentially hazardous situation, which if not avoided, could result in equipment damage, data loss, performance degradation, or unexpected results.
 Danger	Indicates a hazard with a high level of risk, which if not avoided, will result in death or serious injury.

Safety Instructions



- **Caution:** The device may generate radio interference in indoor environment. Necessary precautions may be required.
- In the use of the product, you must be in strict compliance with the electrical safety regulations of the nation and region.
- Input voltage should meet both the SELV (Safety Extra Low Voltage) and the Limited Power Source with 100 to 240 VAC or 12 VDC/2 A according to the IEC60950-1 standard.
- **CAUTION:** Replace the fuse only with the same model to reduce the risk of fire or electric shock.
- The device must be connected to an earthed mains socket-outlet.
- Make sure that the power has been disconnected before you wire, install, or disassemble the device.
- **CAUTION:** This device is for use only with specified bracket (Hikvision's monitor stand). Use with other (carts, stands, or carriers) may result in instability causing injury.
- To prevent possible hearing damage, do not listen at high volume levels for long periods.
- If the device is not working properly, contact the store where the device was purchased or the nearest service center and do not remove or modify the device in any way. (Our company is not responsible for problems caused by unauthorized modifications or repairs.)

- Do not connect several devices to one power adapter as adapter overload may cause overheating or a fire hazard.

 **Caution**

- The device shall not be exposed to water dripping or splashing and that no objects filled with liquids, such as vases, shall be placed on the equipment.
- Ensure correct wiring of the terminals for connection to an AC mains supply.
- The device has been designed, when required, modified for connection to an IT power distribution system.
-  identifies the battery holder itself and identifies the positioning of the cell(s) inside the battery holder.
- + identifies the positive terminal(s) of equipment which is used with, or generates direct current. - identifies the negative terminal(s) of device which is used with, or generates direct current.
- No naked flame sources, such as lighted candles, should be placed on the equipment.
- The ventilation should not be impeded by covering the ventilation openings with items, such as newspapers, tablecloths, curtains, etc. The openings shall never be blocked by placing the equipment on a bed, sofa, rug or other similar surface.
- Keep product surface clean and dry. Do not operate in humid or explosive environment.
- Avoid contact with exposed circuits. Do not touch exposed contacts or components when powering on the product.
- The USB port of the device is used for connecting to a mouse, a keyboard, or a USB flash drive only.
- Install the device according to the instructions in this manual.
- To prevent injury, this device must be securely attached to the floor/wall in accordance with the installation instructions.
- Do not cause objects to fall on the device or shake the device vigorously, and keep the device away from areas where magnetic field interference exists. Avoid installing the device in a place where the surface vibrates or is vulnerable to shock.
- Do not install the device at high temperatures (above 40 ° C) or low temperatures (below -10 ° C) or high humidity.
- Keep vertical when moving or using the device.
- Proper configuration of all passwords and other security settings is the responsibility of the installer and/or end-user.

Chapter 1 Product Introduction

1.1 Buttons on the Front Panel

The buttons at the bottom-right corner of the front panel are shown as follows.



Figure 1-1 Buttons on the Front Panel

Table 1-1 Button Description

Button	Description
	Power On/Off
	<ul style="list-style-type: none"> ● Second level menu page: Exit menu. ● File selection for USB playing: Play ● Other pages: Display main menu page.
	<ul style="list-style-type: none"> ● Display the current input source. ● All the menu pages: OK
	<ul style="list-style-type: none"> ● First-level page: Previous/Next ● Second-level page: Add/Reduce ● USB playing page: Volume up/down
	<ul style="list-style-type: none"> ● Display all the input sources. ● All the menu pages: Switch to next one.

1.2 Interfaces on the Rear Panel

The interfaces that may be found on the rear panel of the device are defined as follows.

Type 1

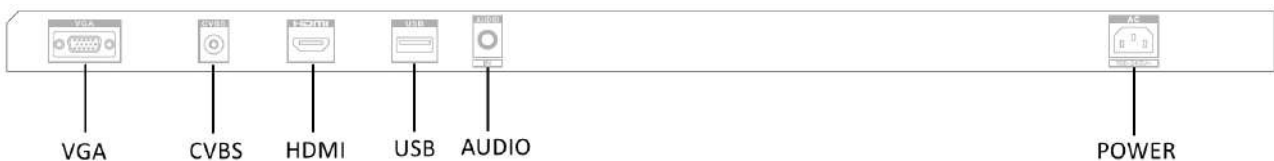

Figure 1-2 Interfaces on the Rear Panel

Type 2

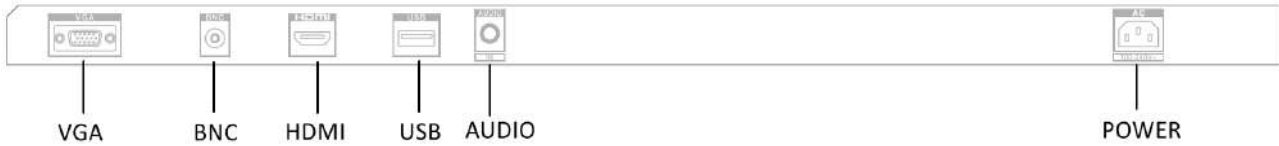

Figure 1-3 Interfaces on the Rear Panel

Table 1-2 Interface Description

Interface	Description
VGA	VGA analog signal input interface
CVBS	CVBS signal input interface
BNC	BNC signal input interface
HDMI	HDMI digital signal input interface
USB	USB 2.0 input interface
AUDIO	Audio input interface
POWER	Power supply

 **Note**

CVBS input interface is available to type 1. BNC input interfaces is available to types 2.

1.3 Power On

Connect the device to an earthed mains socket-outlet, and press the power button.

 **Caution**

- Power Supply: 220 VAC~, 50/60 Hz.
- Power off the device and disconnect the plug if it is not in use for a long time.
- The device cannot be connected to DC power supply.

Chapter 2 Installation

 **Note**

The installation drawings are for reference only.

Step 1 Gently lift the device. Place the screen down on a stable surface covered with a thick soft cloth so that the bottom of the device is close to the edge of the surface for mounting the bracket.

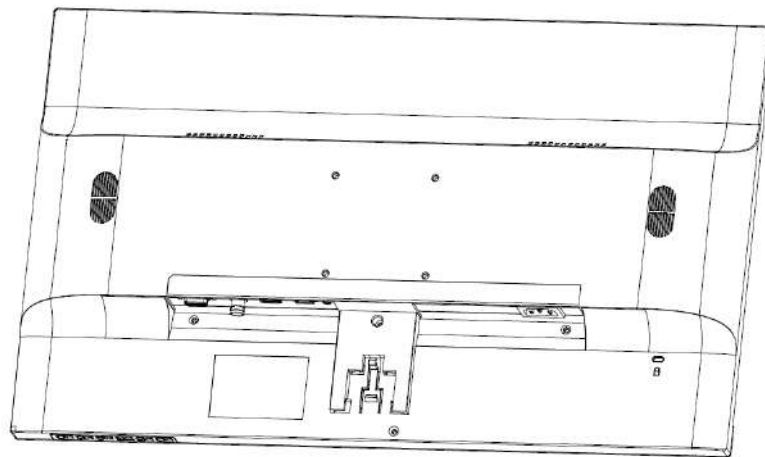

Figure 2-1 Place the Monitor

Step 2 Take out the bracket and round base from the packing box. Align the bracket with the buckle on the base and fix the bracket clockwise.

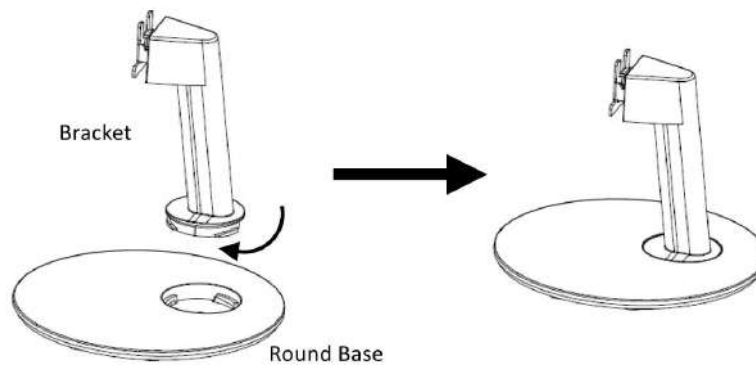

Figure 2-2 Fix the Bracket with the Round Base

Step 3 Align the metal parts on the bracket of round base with the slots at the back of the device and insert them.

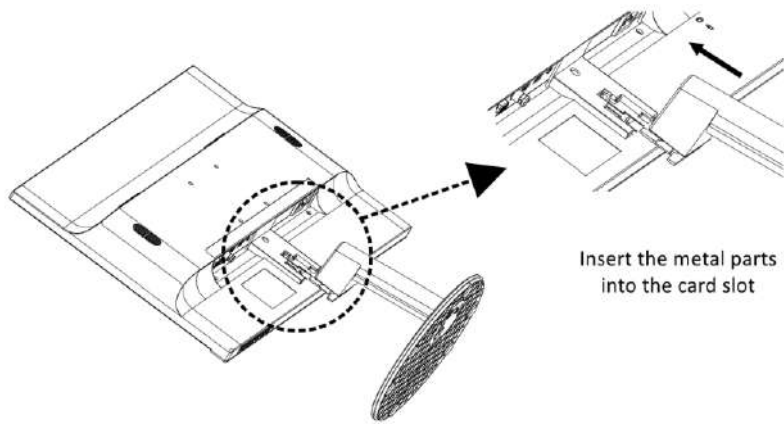

Figure 2-3 Insert the Metal Parts

Step 4 Installation finished.

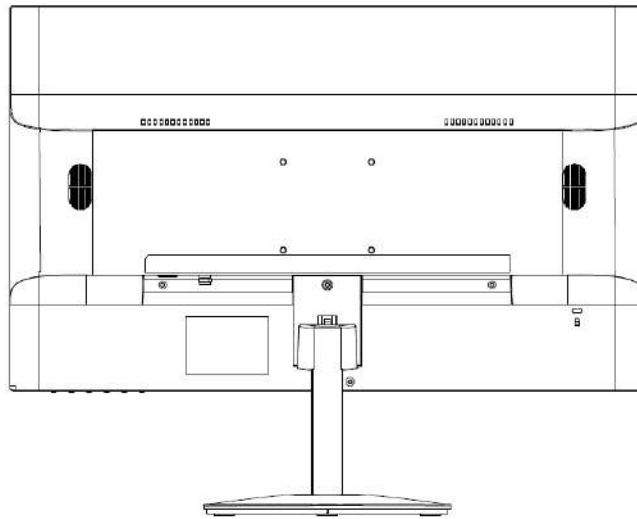











Figure 2-4 Fix the Bracket with the Device

Chapter 3 Remote Control

Table 3-1 Remote Control Description

Appearance	Button	Description
		Power on/off
		Mute/Unmute
	[FREEZE]	Freeze the current display
	[MENU]	Go to menu settings
	[SOURCE]	Check or select a signal source.
		Up/Down/Left/Right
	[OK]	OK
		Play/Pause
		Stop
		Previous/Next
		Repeat
		Return

 **Note**

- The remote control is not available to all kinds of devices. Whether your device is equipped with a remote control depends on the actual situation.
- Please choose and equip the remote control according to your actual needs.

Chapter 4 Basic Operations

The interfaces vary with different models. The figures followed are for illustration purpose only.



4.1 Switch the Signal Source

Connect the device to power source and signal source, and power on the device.

Step 1 Press  to enter the signal source page.













Figure 4-1 Switch the Signal Source

Step 2 Press  to switch input sources, and press  to confirm.

4.2 Menu Operation

Table 4-1 Basic Operation

Operation	Description
Enter main menu page	Press  .
Check first-level menu	On the main menu page, press  or  to switch.
Check second-level menu	On the first menu page, press  to switch.
Check parameters	On the second menu page, press  to enter and check different parameters.
Configure parameters	Press  or  to adjust the value of the selected parameter, and press  to confirm. Press  to switch to other parameters.
Return to the upper menu	Press  on any pages.

4.2.1 Image Settings

Image Mode

You can switch image modes and adjust image parameters including contrast, brightness, color, sharpness, and hue. The adjustable parameters will change when you switch from one image mode to another.



Figure 4-2 Image Mode

Table 4-2 Image Parameters

Parameter	Description
Image Mode	<ul style="list-style-type: none"> ● Standard: Suitable for a normal environment. It is set as default picture mode. ● Gentle: Suitable for a dark room. ● Dynamic: Suitable for a bright room ● User: Set the brightness, contrast, color, sharpness or hue to adjust display effect.
Brightness	Ranges from 0 to 100. The higher the value is, the brighter the display will be.
Contrast	Ranges from 0 to 100. The higher the value is, the clearer the display will be.
Color	Ranges from 0 to 100. The higher the value is, the more colorful the display will be.
Sharpness	Ranges from 0 to 100. Rise the value up to make the image more vivid.
Hue	Ranges from 0 to 100. It determines the contrast degree between the bright and dark.

 **Note**

- If the user mode selected, the adjustable parameters are determined by the input signal.
 - For VGA input, brightness and contrast are adjustable.
 - For HDMI input, brightness, contrast, color, and sharpness are adjustable.

- For BNC input, brightness, contrast, color, and sharpness, and hue are adjustable.
- For USB, brightness, contrast, color, and sharpness are adjustable.
- Parameters in white bar are adjustable. If the parameter bar is gray it indicates that the parameters is not adjustable under the current mode or input source.
- On USB playing page, you can play the selected file.

Backlight

The backlight value range from 0 to 100.



Figure 4-3 Backlight Setting

VGA Parameter

When you select VGA as the input source, you can adjust VGA parameters to make the picture show in the correct position.



Figure 4-4 VGA Settings

Table 4-3 VGA Parameters

Parameter	Description
Manual Adjust	Press < or > to adjust. Adjust the size and position of the image.
Row	Ranges from 0 to 100. Move the image position to the left or right.
Column	Ranges from 0 to 100. Move the image position to the top or bottom.
Phase	Ranges from 0 to 100. Adjusting the value of Phase will change the image position in a slight extent at the horizontal level.
Clock	Ranges from 0 to 100. Changing the value of Clock will stretch or narrow the image.
Auto Adjust	Press < or > to turn off or turn on. If Auto Adjust is enabled, the related parameters will self-adjust under the following 3 circumstances. The device is restarted, a VGA input source is accessed, and the input source is switched to VGA. VGA parameters cannot be changed when Auto Adjust is disabled.

4.2.2 Display Settings

Shielding Switch

If **Shielding Switch** is on, you can set the value of the top, bottom, left, right edge. The value indicates the covered units of different directions.



Figure 4-5 Overscan

Table 4-4 Overscan Parameters

Parameter	Description
Shielding Switch	On/Off
Left Edge	Ranges from 0 to 100
Right Edge	Ranges from 0 to 100
Top Edge	Ranges from 0 to 100
Bottom Edge	Ranges from 0 to 100

Aspect

Scale up/down the image. Three kinds of aspects are available: 16:9, 4:3, and point to point.

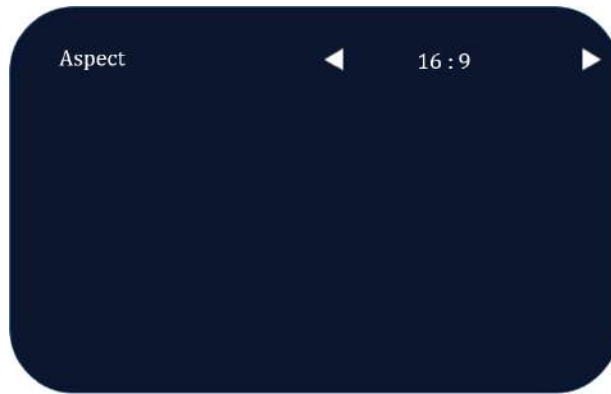

Figure 4-6 Aspect

Note

Point to Point mode is only available when a VGA or HDMI signal is accessed.

Keypad

You can enable or disable the keypad of the device. If there is no need to use the keypad or the keypad is squeezed in the installation environment, you can turn off the keypad to disable the buttons on it. You can enable the keypad by long pressing the MENU button on remote control.



Figure 4-7 Enable/Disable the Keypad

Eye Care Mode

You can enable or disable the **Eye Care Mode** of the device. Once enabled the mode, it can effectively reduce blue light radiation, alleviate eye fatigue, and protect your vision.



Figure 4-8 Eye Care Mode

4.2.3 System Info and Maintenance

System Maintenance

Contact our technical support personnel for upgrade program and USB driver.

- Upgrade: Insert the USB driver to the USB interface, and set **Upgrade (USB)** as **On**. Follow the instructions on the screen to upgrade.
- Restore Defaults: Restore all the settings to the default value.



Figure 4-9 System Maintenance

System Info

Check the software version, working hours, ID, and serial number of the device.



Figure 4-10 System Information

4.2.4 System Settings

OSD Settings

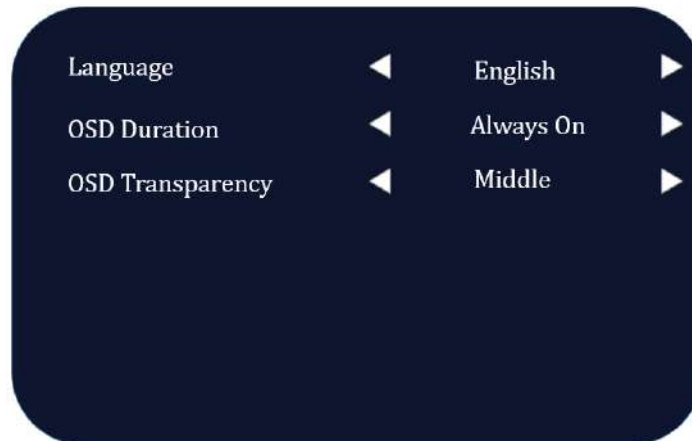

Figure 4-11 OSD Settings

Table 4-5 OSD Parameters

Parameter	Description
Language	Chinese/English
OSD Duration	Always On/5 s/15 s/30 s. The displaying time for OSD menu when no operation is done.
OSD Transparency	Low/Middle/High/Off

Audio Mode

You can set the volume as desired or mute/unmute the playing.



Figure 4-12 Audio Mode

Table 4-6 Audio Mode Parameters

Parameter	Description
Mute	Off/On. Off by default.
Volumn	Ranges from 0 to 100.
Balance	Ranges from 0 to 100.

Other Settings

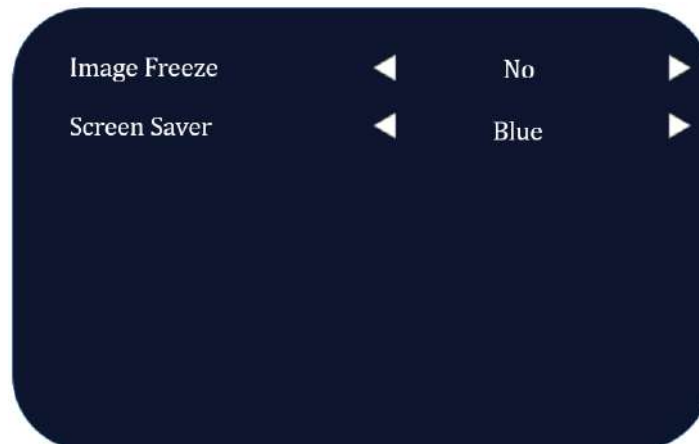

Figure 4-13 Other Settings

Table 4-7 Other Settings

Parameters	Description
Image Freeze	Yes/No
Screen Saver	Logo/Blue/Black Screen

Color Space Setting



Figure 4-14 Color Space Setting

Table 4-8 Color Space Parameter



Parameter	Description
Color Space	Auto/16-235/0-255

4.3 USB Menu

Note

Step 1 Press  , and insert your removable storage device into the USB interface of the device.

Step 2 Select USB as the input signal source, and then the USB menu displays.

Step 3 Press  or  to select your desired file type for playing.

Step 4 Press  to confirm.

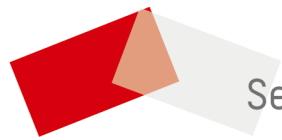

See Far, Go Further