



# DS-1200KI/DS-1006KI Keyboard

User Manual

## About this Document

- This Document includes instructions for using and managing the Product. Pictures, charts, images and all other information hereinafter are for description and explanation only.
- The information contained in the Document is subject to change, without notice, due to firmware updates or other reasons. Please find the latest version of the Document at the Hikvision website (<https://www.hikvision.com>). Unless otherwise agreed, Hangzhou Hikvision Digital Technology Co., Ltd. or its affiliates (hereinafter referred to as "Hikvision") makes no warranties, express or implied.
- Please use the Document with the guidance and assistance of professionals trained in supporting the Product.

## About this Product

- This product can only enjoy the after-sales service support in the country or region where the purchase is made.
- If the product you choose is a video product, please scan the following QR code to obtain the "Initiatives on the Use of Video Products", and read it carefully.



## Acknowledgment of Intellectual Property Rights

- Hikvision owns the copyrights and/or patents related to the technology embodied in the Products described in this Document, which may include licenses obtained from third parties.
- Any part of the Document, including text, pictures, graphics, etc., belongs to Hikvision. No part of this Document may be excerpted, copied, translated, or modified in whole or in part by any means without written permission.
- **HIKVISION** and other Hikvision's trademarks and logos are the properties of Hikvision in various jurisdictions.
- Other trademarks and logos mentioned are the properties of their respective owners.

## LEGAL DISCLAIMER

- TO THE MAXIMUM EXTENT PERMITTED BY APPLICABLE LAW, THIS DOCUMENT AND THE PRODUCT DESCRIBED, WITH ITS HARDWARE, SOFTWARE AND FIRMWARE, ARE PROVIDED "AS IS" AND "WITH ALL FAULTS AND ERRORS". HIKVISION MAKES NO WARRANTIES, EXPRESS OR IMPLIED, INCLUDING WITHOUT LIMITATION, MERCHANTABILITY, SATISFACTORY QUALITY, OR FITNESS FOR A PARTICULAR PURPOSE. THE USE OF THE PRODUCT BY YOU IS AT YOUR OWN RISK. IN NO EVENT WILL HIKVISION BE LIABLE TO YOU FOR ANY SPECIAL, CONSEQUENTIAL, INCIDENTAL, OR INDIRECT DAMAGES, INCLUDING, AMONG OTHERS, DAMAGES FOR LOSS OF

BUSINESS PROFITS, BUSINESS INTERRUPTION, OR LOSS OF DATA, CORRUPTION OF SYSTEMS, OR LOSS OF DOCUMENTATION, WHETHER BASED ON BREACH OF CONTRACT, TORT (INCLUDING NEGLIGENCE), PRODUCT LIABILITY, OR OTHERWISE, IN CONNECTION WITH THE USE OF THE PRODUCT, EVEN IF HIKVISION HAS BEEN ADVISED OF THE POSSIBILITY OF SUCH DAMAGES OR LOSS.

- YOU ACKNOWLEDGE THAT THE NATURE OF THE INTERNET PROVIDES FOR INHERENT SECURITY RISKS, AND HIKVISION SHALL NOT TAKE ANY RESPONSIBILITIES FOR ABNORMAL OPERATION, PRIVACY LEAKAGE OR OTHER DAMAGES RESULTING FROM CYBER-ATTACK, HACKER ATTACK, VIRUS INFECTION, OR OTHER INTERNET SECURITY RISKS; HOWEVER, HIKVISION WILL PROVIDE TIMELY TECHNICAL SUPPORT IF REQUIRED.
- YOU AGREE TO USE THIS PRODUCT IN COMPLIANCE WITH ALL APPLICABLE LAWS, AND YOU ARE SOLELY RESPONSIBLE FOR ENSURING THAT YOUR USE CONFORMS TO THE APPLICABLE LAW. ESPECIALLY, YOU ARE RESPONSIBLE, FOR USING THIS PRODUCT IN A MANNER THAT DOES NOT INFRINGE ON THE RIGHTS OF THIRD PARTIES, INCLUDING WITHOUT LIMITATION, RIGHTS OF PUBLICITY, INTELLECTUAL PROPERTY RIGHTS, OR DATA PROTECTION AND OTHER PRIVACY RIGHTS. YOU SHALL NOT USE THIS PRODUCT FOR ANY PROHIBITED END-USES, INCLUDING THE DEVELOPMENT OR PRODUCTION OF WEAPONS OF MASS DESTRUCTION, THE DEVELOPMENT OR PRODUCTION OF CHEMICAL OR BIOLOGICAL WEAPONS, ANY ACTIVITIES IN THE CONTEXT RELATED TO ANY NUCLEAR EXPLOSIVE OR UNSAFE NUCLEAR FUEL-CYCLE, OR IN SUPPORT OF HUMAN RIGHTS ABUSES.
- IN THE EVENT OF ANY CONFLICTS BETWEEN THIS DOCUMENT AND THE APPLICABLE LAW, THE LATTER PREVAILS.



**© Hangzhou Hikvision Digital Technology Co., Ltd. All rights reserved.**

## Applicable Models

This manual is applicable to DS-1200KI and DS-1006KI keyboard models.

## Symbol Conventions

The symbols that may be found in this document are defined as follows.

Symbol	Description
 <b>NOTE</b>	Provides additional information to emphasize or supplement important points of the main text.
 <b>WARNING</b>	Indicates a potentially hazardous situation, which if not avoided, could result in equipment damage, data loss, performance degradation, or unexpected results.
 <b>DANGER</b>	Indicates a hazard with a high level of risk, which if not avoided, will result in death or serious injury.

## TABLE OF CONTENTS

Chapter 1 Getting Started .....	1
1.1 Activate Your Device.....	1
1.2 Login .....	2
1.2.1 Local Login.....	2
1.2.2 Remote Login (via Web browser).....	2
1.3 System Menu.....	3
Chapter 2 Web Configuration .....	5
2.1 Device Mangement .....	5
2.1.1 Add Devices.....	5
2.1.2 Manage Input/Output Channels .....	6
2.2 System Management .....	10
2.2.1 View Version Information .....	10
2.2.2 User Management .....	10
2.2.3 Maintenance .....	11
2.2.4 Security.....	14
2.3 Network Management .....	15
2.4 Serial Port Settings .....	15
2.5 Matrix Access Gateway .....	16
2.6 Platform Access.....	17
2.6.1 Connect to KPS.....	17
2.6.2 Connect to Third-Party Platform .....	17
2.6.3 Connect to HikCentral .....	17
Chapter 3 Keyboard Operation .....	19
3.1 Keyboard Operation .....	20
3.1.1 Video Wall Control .....	20
3.1.2 Call Presets/Patrols/Patterns .....	21
3.1.3 Call Scenes.....	22
3.2 MAG by IP.....	22
3.3 DVR by IP .....	23
3.4 MAG by RS-422 .....	24
3.5 DVR by RS-485.....	25
3.6 To Analog Device .....	26
3.6.1 Dome by RS-485 .....	26

3.6.2 Dome by RS-232 .....	27
3.6.3 Analog Matrix by RS-232 .....	28
3.7 Platform Access .....	29
3.7.1 Access to KPS by Network .....	29
3.7.2 Access to Third-Party Platform by Network .....	29
3.7.3 Access to HikCentral .....	30
3.8 Shortcut Operation .....	32
Chapter 4 System Menu Configuration .....	34
4.1 Version .....	34
4.2 Network .....	34
4.2.1 DHCP .....	34
4.2.2 SADP .....	34
4.2.3 SSH .....	34
4.3 User Management .....	35
4.4 Serial Port Settings .....	35
4.5 Hardware .....	36
4.6 Time Settings .....	36
4.7 Maintenance .....	36

# Chapter 1 Getting Started

## 1.1 Activate Your Device

**Purpose:**

For the first-time access, you need to activate the device by setting an admin password. No operation is allowed before activation. You can also activate the device via SADP as well.

Step 1 In the Device Activation interface, enter the admin password in the text field of **Admin Password** and **Confirm**.



In edit mode, you can press the FOCUS+/A button on the keyboard panel to switch the character input mode: numerals (123), upper case (ABC) and lower case (abc).

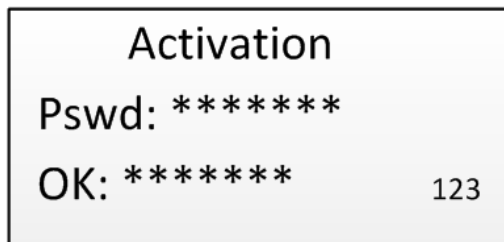

Figure 1-1 Activation Interface



**STRONG PASSWORD RECOMMENDED**—We highly recommend that you create a strong password of your own choosing (8 to 16 characters, including upper case letters, lower case letters, and numbers) in order to increase the security of your product. And we recommend that you reset your password regularly, especially in the high security system, resetting the password monthly or weekly can better protect your product.

---

Step 2 Click **Confirm** to finish the device activation.

 **NOTE**

- After the device is activated, you need to adjust the date and time settings.
- If you have restored the device to default settings, you need to reactivate the device.

## 1.2 Login

***Purpose:***

You must log in to the device before configuring the keyboard, and operating the menu and other functions. DS-1200KI keyboards support two ways of login: local login and remote login (by Web browser). DS-1006KI keyboards support local login only.

### 1.2.1 Local Login

Step 1 In the Login interface, enter the user name in the User Name field.

Step 2 Enter the password in the Password field.

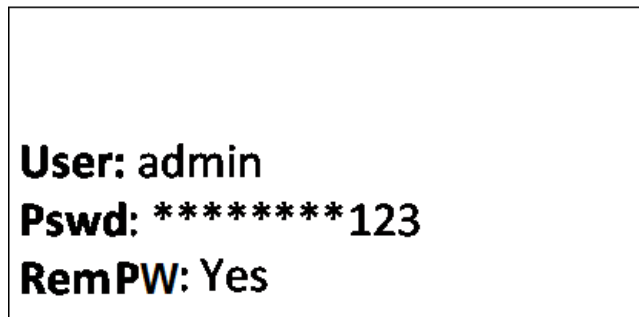

Figure 1-2 Login Interface

Step 3 Press the **OK** button to log in to the device.

 **NOTE**

- In the Login dialog box, if you enter the wrong password 7 times for admin user or 5 times for operators, the current user account will be locked for 30 minutes.
- If you select Remember Password, the system will remember the password for the current user without remembering the previous one.

### 1.2.2 Remote Login (via Web browser)

This section applies to DS-1200 KI keyboards.

Step 1 On the keyboard, enter the network settings menu.

**System > Network**

Step 2 Use the joystick to set the DHCP **OFF** or **ON**.



If you set the DHCP to ON, the system automatically obtains a network address.

If you set the DHCP to OFF, continue to set the network parameters, including the IP Address, Gateway and Subnet Mask.

Step 3 Press **OK** to save the settings.

Step 4 Open the Web browser, and enter the address (**https://IP address**) to enter the device login page.

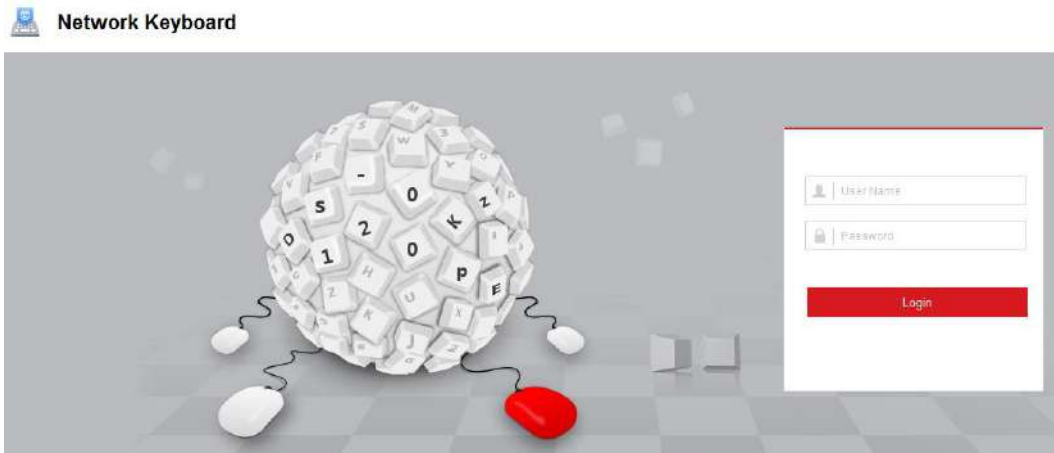

Figure 1-3 Login Interface

Step 5 Enter the user name and password in the field.

Step 6 Click **Login** to log in to the device.

## 1.3 System Menu

This section uses the DS-1200KI keyboard as an example to show the system menu items.

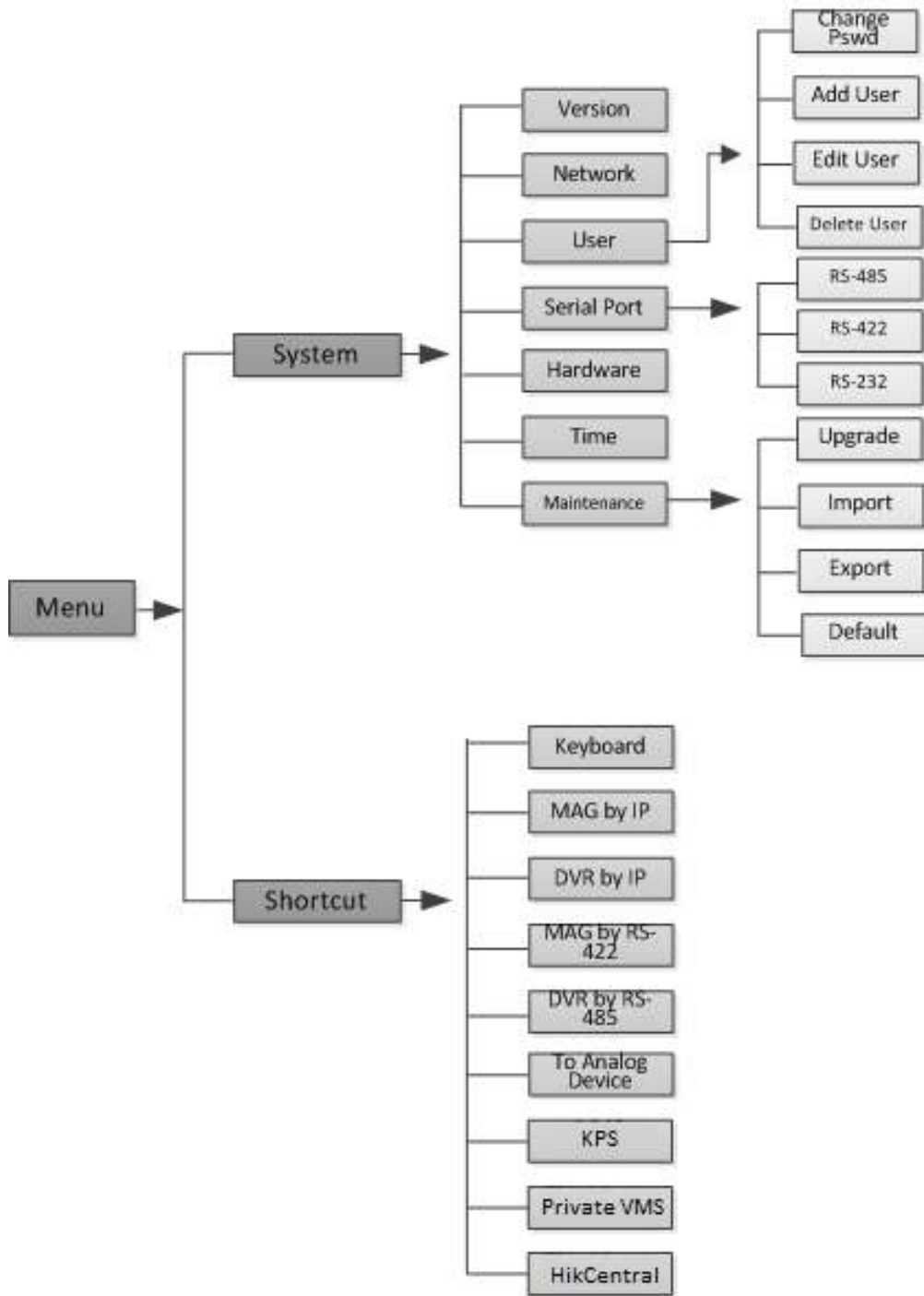

Figure 1-4 DS-1200KI System Menu

## Chapter 2 Web Configuration

This section applies to DS-1200KI keyboards only.

### 2.1 Device Management

#### 2.1.1 Add Devices

**Purpose:**

In Keyboard Operation mode, follow instructions in this section to add devices first before realizing the operation and control of the devices on the keyboard.

You are recommended to back up and edit the channel list using an Excel file. For adding devices for the first time, add a couple of devices first and then export it as a template. For details, see section 2.1.2 Manage Input/Output Channels.

Step 1 Log in to the device.

Step 2 Go to **Device Management > Device List**.

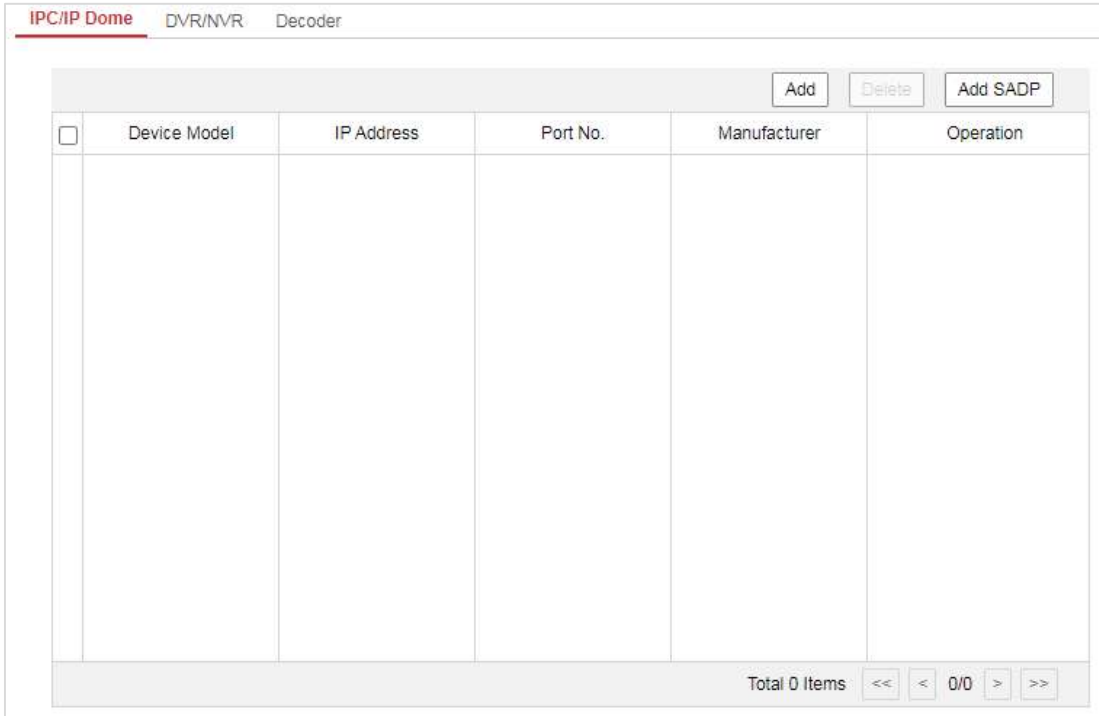

<input type="checkbox"/>	Device Model	IP Address	Port No.	Manufacturer	Operation
--------------------------	--------------	------------	----------	--------------	-----------

Total 0 Items << < 0/0 > >>

Figure 2-1 Device List

Step 3 Select a device type (IPC/IP Dome, DVR/NVR or Decoder) and click **Add** to add the devices.

Figure 2-2 Add Device

Step 4 You can add the device by IP or by IP segment. Enter the network parameters, including the IP address, port, login user name, and password.

Step 5 Select **Manufacturer**.



NOTE

You can add devices of ONVIF protocol.

Step 6 Click **OK** to save the settings. The successfully added device is shown in the list.

<div style="text-align: right;"> <input type="button" value="Add"/> <input type="button" value="Delete"/> <input type="button" value="Add SADP"/> </div>					
<input type="checkbox"/>	Device ID	Device Model	IP Address	Port No.	Operation
<input type="checkbox"/>	1				<input type="button" value="Edit"/> <input type="button" value="Delete"/>

Figure 2-3 Successfully Added Device



NOTE

You can also click the **Add SADP** to add the online devices in the same network segment.

Step 7 (Optional) After adding the device, you can click **Edit** to edit the parameters, or click **Delete** to delete the added device.

## 2.1.2 Manage Input/Output Channels

### **Purpose:**

You can manage the importing and exporting of input channels in batch, input group, and output channels via web browser.

## Import and Export Input Channel List

Step 1 Go to **Device Management > Input Channel > Input List**.

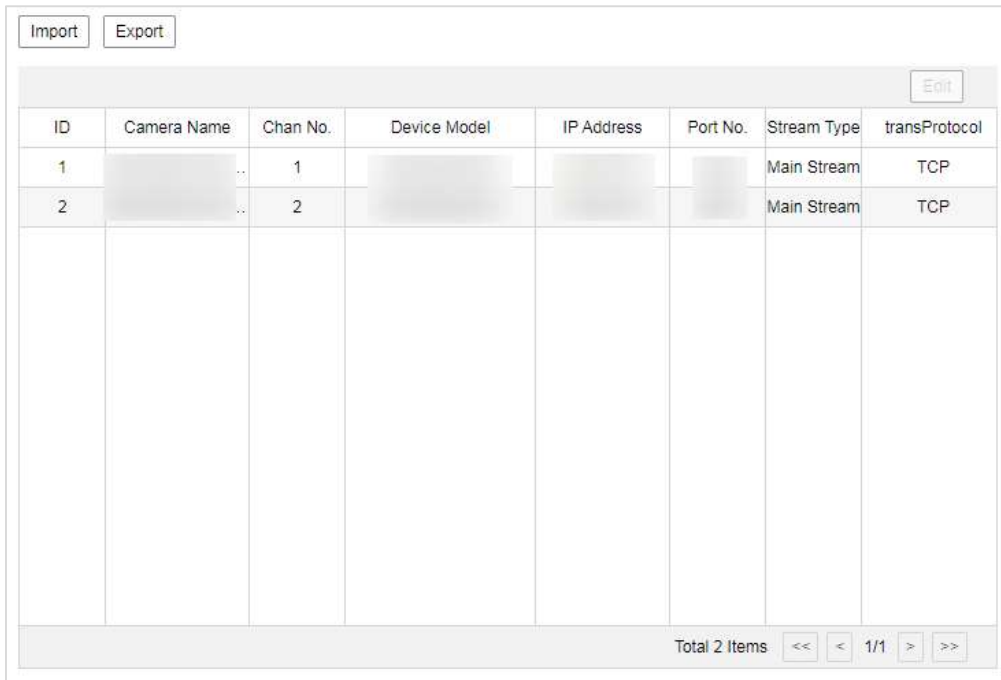

ID	Camera Name	Chan No.	Device Model	IP Address	Port No.	Stream Type	transProtocol
1	...	1	...	...	...	Main Stream	TCP
2	...	2	...	...	...	Main Stream	TCP

Total 2 Items << < 1/1 > >>

Figure 2-4 Input List

Step 2 (Optional) You can select an input channel from the list and click **Edit** to edit the parameters including the input channel ID, camera name, stream type, and protocol type.

Step 3 Import input channel list from the local directory.

- 1) Click **Import**.
- 2) Click **Browse** to select the input channel list (in excel) from the local directory.
- 3) Enter the admin **Password**.
- 4) Click **OK**.

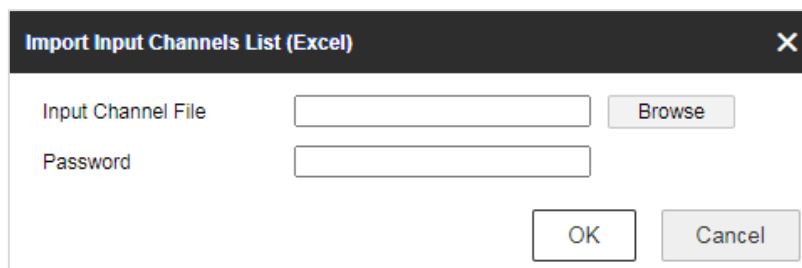

**Import Input Channels List (Excel)**

Input Channel File

Password

Figure 2-5 Import Input Channel List

Step 4 Export input channel list to the local directory.

- 1) Click **Export**.
- 2) Enter the admin **Password**.

3) Click **OK**.

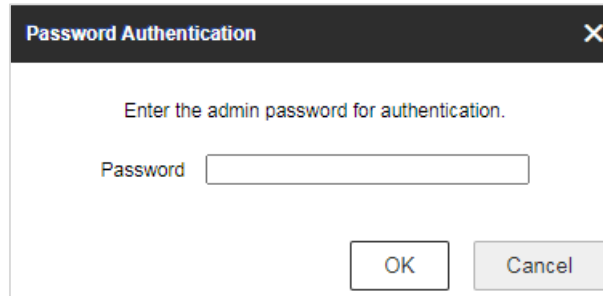

A dialog box titled "Password Authentication" with a close button (X) in the top right corner. The text inside reads "Enter the admin password for authentication." Below this is a text input field labeled "Password". At the bottom of the dialog are two buttons: "OK" and "Cancel".

Figure 2-6 Export Input Channel List



You are recommended to save the exported list first, and then open it. Opening it directly is not recommended.

## Add Auto-Switch Groups

### **Purpose:**

You can classify the input channels, and realize the auto switch of one group of cameras.

Step 1 Go to **Device Management > Input Channel > Input Group**.

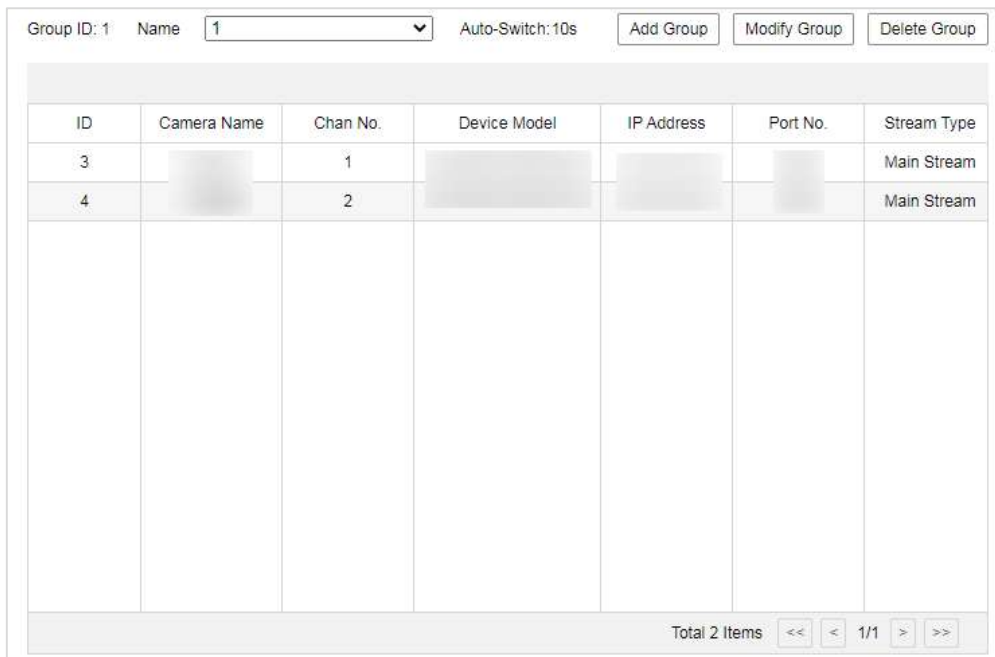

The interface shows a configuration page for an input group. At the top, there are fields for "Group ID: 1", "Name" (a dropdown menu with "1" selected), and "Auto-Switch: 10s". To the right of these fields are three buttons: "Add Group", "Modify Group", and "Delete Group". Below this is a table with the following columns: ID, Camera Name, Chan No., Device Model, IP Address, Port No., and Stream Type. The table contains two rows of data. At the bottom right of the table area, it says "Total 2 Items" followed by navigation buttons: "<<", "<", "1/1", ">", and ">>".

ID	Camera Name	Chan No.	Device Model	IP Address	Port No.	Stream Type
3		1				Main Stream
4		2				Main Stream

Figure 2-7 Input Group

Step 2 Add input group.

- 1) Click **Add Group**.
- 2) Check the channels to be added into one group.

- 3) Enter the group name and auto-switch interval (10 to 10000 sec).
- 4) Click **OK**.

<input type="checkbox"/>	ID	Camera Name	Chan No.	Device Model	IP Address	Port No.
<input type="checkbox"/>	1		1			
<input type="checkbox"/>	2		2			
<input checked="" type="checkbox"/>	3		1			
<input checked="" type="checkbox"/>	4		2			

Figure 2-8 Add Input Group

Step 3 (Optional) Select a group from the list, and click **Modify Group** to edit. Click **Delete Group** to delete the added group.

 **NOTE**

Up to 16 input groups can be added, and up to 64 input channels can be added for each group.

### Manage Output Channel

Step 1 Go to **Device Management > Output Channel**.

Step 2 You can check the output channel information, or select an output channel from the list and edit the channel ID.

## 2.2 System Management

### 2.2.1 View Version Information

Go to **System Management > Version > Version** to view the device version information. Go to **System Management > Version > About**, and click **View License** to view the open source software license.

### 2.2.2 User Management

The default user account of the device is admin (administrator), and the password is set when you start the device for the first time. The admin user account has the permission to add and delete operator accounts and configure user parameters, and add the related devices for the added users.



**NOTE**

You can set 1 administrator and 15 operator accounts.

Step 1 Go to **System Management > User Management > User Management**.

Step 2 Click **Add** to add user.

Step 3 Edit the user name, enter the admin password, set password (strong password is highly recommended) for the added user, and confirm the password.



**WARNING**

**STRONG PASSWORD RECOMMENDED**—We highly recommend that you create a strong password of your own choosing (using a minimum of 8 to 16 characters, including upper case letters, lower case letters, and numbers) in order to increase the security of your product. And we recommend that you reset your password regularly, especially in the high security system, resetting the password monthly or weekly can better protect your product.

---

Step 4 Select the linked device(s) from the list for the user.



**Add User** [X]

User Name:  ✓

Admin Password:  ✓

Password:  ✓  
 Strong  
 8-16 characters allowed, and you can use a combination of numbers, lowercase and uppercase letters for your password with at least two kinds of them contained.

Confirm Password:  ✓

**Select Linked Device** [Select All]

<input checked="" type="checkbox"/>	ID	Device Type	IP Address	Port No.	Device Model
<input checked="" type="checkbox"/>					
<input checked="" type="checkbox"/>	1				

Selected 2 Total 2 Items << < 1/1 > >>

[OK] [Cancel]

Figure 2-9 Add User

Step 5 Click **OK**.

Step 6 (Optional) Select the admin or added user from the user list, and click **Edit** to edit the parameters. Or select the added user and click **Delete** to delete the user.

## 2.2.3 Maintenance

### Reboot Device

Step 1 Go to **System Management > Maintenance > Maintenance > Remote Reboot**.

Step 2 Click **Remote Reboot**.

Step 3 Click **OK** to reboot the device.

### Restore Device to Factory Settings

Step 1 Go to **System Management > Maintenance > Maintenance > Restore the factory defaults**.

Step 2 Click **Complete**.

Step 3 Enter the admin password, and click **OK** to restore the device to the factory settings.

### Export Configuration File

You can export the parameters of one device, and import them to another device to set the two devices with the same parameters.

Step 1 Go to **System Management > Maintenance > Maintenance > Export Config**.

Step 2 Click **Config File**.

Step 3 Enter **Admin Password**.

Step 4 Set **File Password**, and confirm the file password.



The password is used for importing the configuration file of the current device to other devices.

Step 5 Click **OK**.

### Import Configuration File

Import the configuration file of another device to the current device to set the same parameters.

#### Before You Start

Save the configuration file to the computer.



Importing configuration file is only available to the devices of the same model and same version.

Step 1 Go to **System Management > Maintenance > Maintenance > Import Config**.

Step 2 Click **Browse** to select the configuration file.



The configuration file is in the format of BIN.

Step 3 Click **Import**.

Step 4 Click **OK** on the popup window.

#### Result

The device will reboot automatically after the configuration file is imported.

## Upgrade

Upgrade the system when you need to update the device version.

### Before You Start

Prepare the upgrade file. It is named as “digicap.dav”.

Step 1 Go to **System Management > Maintenance > Maintenance > Remote Upgrade**.

Step 2 Click **Browse** to select the upgrade file.

Step 3 Click **Upgrade**.

Step 4 Click **OK** in the popup window.



### Note

The upgrade process will take 1 to 10 minutes. Do not cut off the power supply.

---

### Result

The device will reboot automatically after upgrade.

## Search Log

Log helps to locate and troubleshoot problems.

Step 1 Go to **System Management > Maintenance > Log**.

Step 2 Set search conditions.

Step 3 Click **Search**.

The matched logs will be displayed on the log list.

SN	Time	Major Type	Minor Type	Local/Remote User	Remote Host IP	Description
1	2023-08-31 16:14:42	Operation	Remote: Export configura...	admin		Config
2	2023-08-31 16:00:09	Operation	Remote: Login	admin		
3	2023-08-31 15:27:34	Operation	Remote: Configure para...	admin		Add User[user1]
4	2023-08-31 14:46:50	Operation	Remote: Configure para...	admin		Add CAMG[1]
5	2023-08-31 14:45:47	Operation	Remote: Configure para...	admin		Del CAMG[1]
6	2023-08-31 14:38:43	Operation	Remote: Configure para...	admin		Add CAMG[1]
7	2023-08-31 14:33:55	Operation	Remote: Login	admin		
8	2023-08-31 12:27:30	Operation	Remote: Add the device	admin		Add DEV[10.12....
9	2023-08-31 12:19:17	Operation	Remote: Export configura...	admin		Excel
10	2023-08-31 11:45:25	Operation	Remote: Login	admin		
11	2023-08-31 11:05:00	Operation	Remote: Add the device	admin		Add DEV[10.65....
12	2023-08-31 10:58:28	Operation	Remote: Login	admin		

Total 15 Items << < 1/1 > >>

Figure 2-10 Log

Step 4 (Optional) Click **Export** and enter the admin password to save the log files to your computer.

## 2.2.4 Security

Step 1 Go to **System Management > Security Settings > Security Settings**.

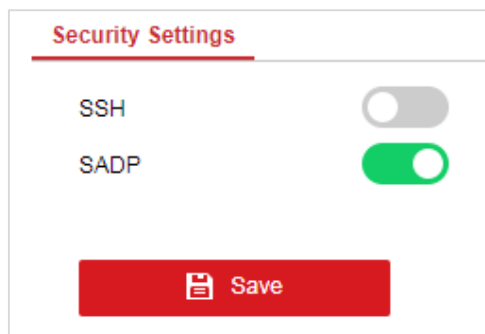

Figure 2-11 Security

Step 2 Set **SSH** and **SADP**.

- **SSH**: You are recommended to disable SSH service.
- **SADP**: If you enable the function, the device can be searched via the SADP software in the same network segment.

Step 3 Click **Save**.

## 2.3 Network Management

Set the IP address of the device.

Step 1 Go to **Network Management > IP Address Settings**.

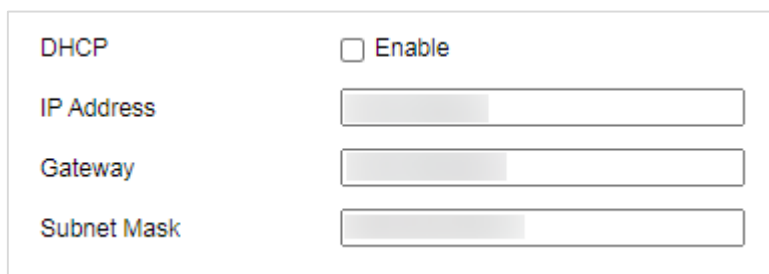

DHCP	<input type="checkbox"/> Enable
IP Address	<input type="text" value="192.168.1.1"/>
Gateway	<input type="text" value="192.168.1.1"/>
Subnet Mask	<input type="text" value="255.255.255.0"/>

Figure 2-12 Set IP Address

Step 2 Set the IP address in two ways.

- Check **DHCP**. The device will automatically get the IP parameters from the network. The device IP address is changed after enabling the function. You can use SADP to get the device IP address.



The network that the device is connected to should support DHCP (Dynamic Host Configuration Protocol).

- Uncheck **DHCP**, and set the IP address manually. Enter **IP Address**, **Gateway**, and **Subnet Mask**.

Step 3 Click **Save**.

## 2.4 Serial Port Settings

Set the RS-485, RS-422, and RS-232 serial port parameters. Use RS-485 serial port when connecting with analog speed domes and DVR/NVRs. Use RS-422 serial port when connecting with gateways and iVMS. Use RS-232 serial port when connecting with analog matrixes or speed domes via VISCA.

Step 1 Click **Serial Port Settings**.

Step 2 Select **RS485**, **RS422**, or **RS232** to set the corresponding parameters.

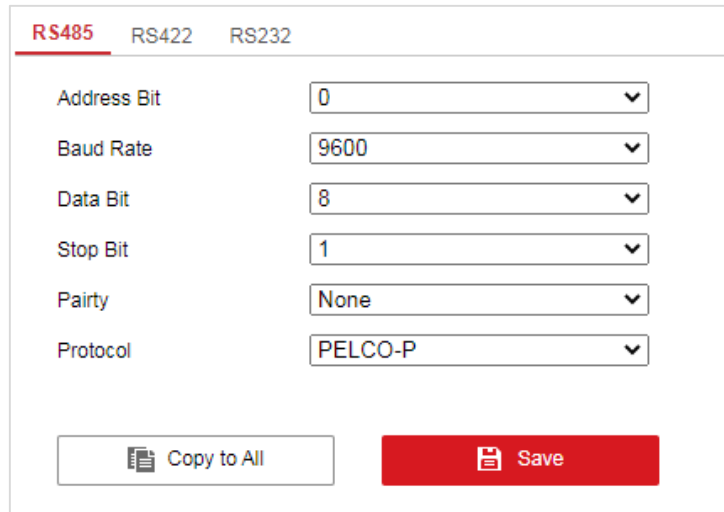

RS485	RS422	RS232
Address Bit		
Baud Rate		
Data Bit		
Stop Bit		
Parity		
Protocol		

Copy to All Save

Figure 2-13 Set Serial Port

Step 3 (Optional) Click **Copy to All** to copy the settings to other serial ports of the same type.

Step 4 Click **Save**.

## 2.5 Matrix Access Gateway

The device can connect with the matrix access gateway, and realize the video wall control, PTZ control, etc.

Step 1 Click **Matrix Access Gateway**.

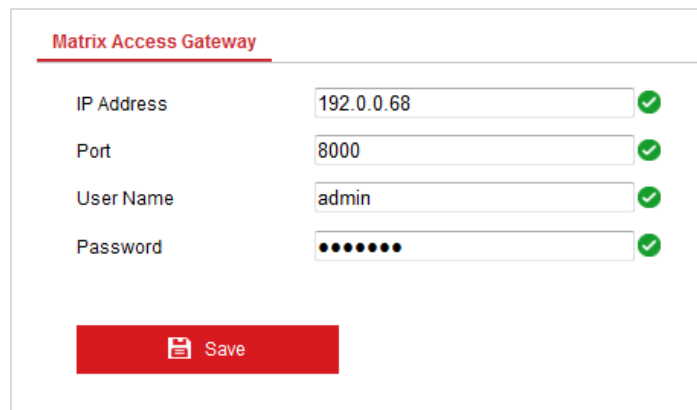

Matrix Access Gateway	
IP Address	192.0.0.68 ✓
Port	8000 ✓
User Name	admin ✓
Password	•••••• ✓

Save

Figure 2-14 Matrix Access Gateway

Step 2 Set the parameters of the matrix access gateway.

Step 3 Click **Save**.

## 2.6 Platform Access

### 2.6.1 Connect to KPS

KPS refers to Keyboard Proxy Service. DS-1200KI keyboard can be used as a control terminal to connect to KPS to perform video wall and PTZ control.

Step 1 Go to **Platform Access > KPS**.

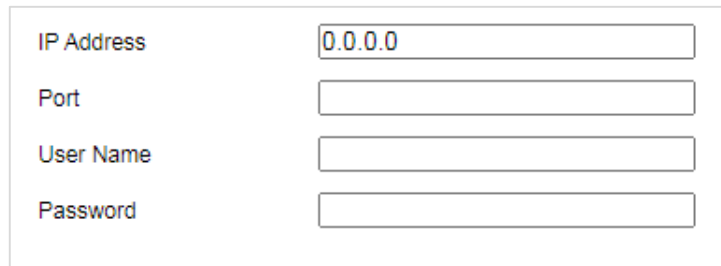

The screenshot shows a configuration form for KPS. It contains four input fields arranged vertically. The first field is labeled 'IP Address' and contains the text '0.0.0.0'. The second field is labeled 'Port' and is empty. The third field is labeled 'User Name' and is empty. The fourth field is labeled 'Password' and is empty.

Figure 2-15 KPS

Step 2 Set **IP Address**, **Port**, **User Name**, and **Password** of KPS.

Step 3 Click **Save**.

### 2.6.2 Connect to Third-Party Platform

The keyboard can be used as a control terminal to connect to the third-party platform to realize the configuration via the third-party platform.

Step 1 Go to **Platform Access > Third-Party Platform**.

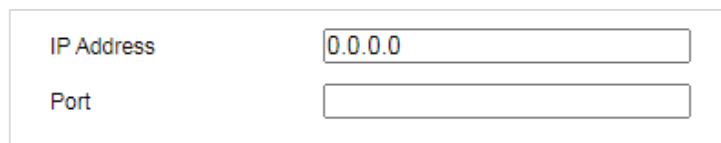

The screenshot shows a configuration form for the Third-Party Platform. It contains two input fields arranged vertically. The first field is labeled 'IP Address' and contains the text '0.0.0.0'. The second field is labeled 'Port' and is empty.

Figure 2-16 Third-Party Platform

Step 2 Set **IP Address** and **Port** of the third-party platform.

Step 3 Click **Save**.

### 2.6.3 Connect to HikCentral

The keyboard can be used as a control terminal to connect to the HikCentral client to perform video wall and PTZ control.

Step 1 Go to **Platform Access > HikCentral**.

IP Address	<input type="text"/>
Protocol	<input type="text" value="https"/>
Port	<input type="text"/>
User Name	<input type="text"/>
Password	<input type="password"/>

Figure 2-17 HikCentral

Step 2 Set **IP Address**, **Protocol**, **Port**, **User Name**, and **Password** of HikCentral.

Step 3 Click **Save**.



## Chapter 3 Keyboard Operation

This section describes how to control devices using the keyboard.

On the keyboard, Press the MODE button on the panel to enter the operation for different devices. DS-1200KI keyboards support the following 9 operation modes, while DS-1006KI keyboards support mode 4, 5, and 6.



Figure 3-1 Operation Mode

See the following table for the description of each keyboard mode.

Table 3-1 Description of Keyboard Mode

SN	Operation Mode	Description
1	Keyboard	The keyboard can be used for managing the devices (including the IPC, IP dome, DVR/NVR, MVC, decoder, video wall controller, etc.) for control. The keyboard can add the devices via Web browser and assign each of them the unique device ID, and finally manage to communicate with and realize the video wall or PTZ control through the <i>device ID+command</i> operation.
2	MAG by IP	The keyboard can connect with the matrix access gateway, and realize the video wall control, PTZ control, etc.
3	DVR by IP	The keyboard can connect with the DVR/NVR and remotely call the device menu and realize PTZ control through the virtual panel.
4	MAG by RS-422	The keyboard can connect with the matrix access gateway via RS-422 serial port, and realize the video wall control, PTZ control, etc.
5	DVR by RS-485	The keyboard can connect with the DVR/NVR via RS-485 serial port, and remotely call the device menu and realize PTZ control through the virtual panel.
6	To Analog Dev	The keyboard can connect with the analog dome or PTZ unit via RS-485 serial port, and realize PTZ control; or connect to analog matrix via RS-232 port.

SN	Operation Mode	Description
7	KPS	DS-1200KI keyboard can be used as a control terminal to connect to KPS (Keyboard Proxy Service) to perform video wall and PTZ control.
8	Private VMS	Use the keyboard as terminal to connect to a third-party platform and support video operations through the platform.
9	HikCentral	The keyboard can be used as a control terminal to connect to the HikCentral client to perform video wall and PTZ control.

## 3.1 Keyboard Operation

The keyboard can be used for managing the devices (including the IPC, IP dome, DVR/NVR, MVC, decoder, video wall controller, etc.) for control.

### 3.1.1 Video Wall Control

**Purpose:**

You can select different window-division display modes for the selected output channel. The configurable multi-division display modes depend on the decoders, video wall controller, or MVCs.



**NOTE**

The 1/2/4/6/8/9/12/16/25/32/36 window-division display modes are configurable.

- Step 1 In the **Keyboard** operation mode, press the *Num + DEV* buttons on the keyboard panel to select the device ID (decoder, MVC and video wall controller).
- Step 2 (Optional): Press the *Num + Video Wall* buttons to select the video wall or joint screen.
- Step 3 Press the *Num + MON* buttons to select the display window for the output channel.
- Step 4 (Optional) Press the *Num + MULT* buttons to set the window-division display mode for the output channel.
- Step 5 Press the *Num + WIN* buttons to set the sub-window to play the decoded video. The selected sub-window ID is shown in [ID] on the interface, e.g., [02].
- Step 6 Press the *Num + CAM/CAM-G* buttons to select the input channel or input channel group. You can press the PREV/NEXT buttons to switch to the previous or next camera / camera group ID.

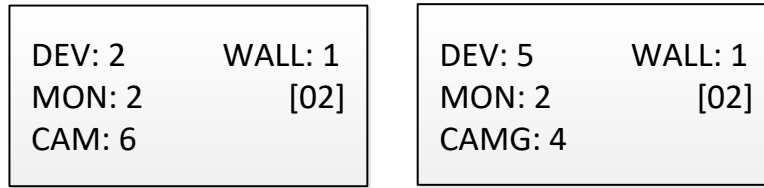

Figure 3-2 Video Wall Operation



- When you enter no device ID (DEV), the first decoder found is set for control by default. And if you enter no WIN ID, the window 01 is set to play the decoded video by default.
- To directly operate the PTZ control, press the *Num + CAM* buttons. Press the *0 + CAM* buttons to stop decoding of the current camera, or press the *0 + CAM-G* buttons to stop cycle decoding of the camera group.
- To control the local decoding channels of NVRs/DVRs, firstly go to the Web interface of the NVRs/DVRs and view the input channel IDs, and then press *Num + CAM* buttons to control the channels.
- For DS-9600 series NVRs, if a decoding card is used for decoding output, you need to firstly drag the output channel to the corresponding display window on the video wall using a client software. Then press *Num + DEV + Num + WIN + Num + CAM/CAM-G* to control the camera without pressing the MON ID.

Step 7 Operate the PTZ control on the video wall.

Move the joystick to realize pan/tilt movement in 8 directions and zoom in/out control.

Rotate the joystick in clockwise/anti-clockwise directions to I to realize the zoom in/out control.

The central button of the joystick can be used to capture picture.

### 3.1.2 Call Presets/Patrols/Patterns

The keyboard can be used to control the PTZ function of the connected IP dome camera, including the pan/tilt movement, zoom/iris/focus adjustment, and preset/patrol/pattern calling.

Step 1 In the **Keyboard** operation mode, press the *Num + MON* buttons to select the output channel ID.

Step 2 Press the *Num + WIN* buttons to set the sub-window to play the decoded video.

Step 3 Press the *Num + CAM* buttons to select the input channel for PTZ control.

Step 4 Call the preset/patrol/pattern.

- Press the *Num + PRESET* buttons on the keyboard panel to call the defined preset.
- Press the *Num + PATROL* buttons on the keyboard panel to call the defined patrol.
- Press the *Num + PATTERN* buttons on the keyboard panel to call the defined pattern.

DEV: 2	WALL: 1
MON: 2	[02]
CAM: 6	
PRESET: 1	

Figure 3-3 Preset Calling

 NOTE

- The preset/patrol/pattern must be pre-configured.
- Whether PTZ functions are available or not depends on the capabilities of speed domes. If the speed domes do not support a PTZ function, the keyboard does not respond.

### 3.1.3 Call Scenes

#### **Purpose:**

For the MVC, video wall controller, and decoder added to the keyboard, you can configure the scene via the client software first and follow the steps below to switch the scene.

Step 1 In the **Keyboard** operation mode, press the *Num + DEV* buttons on the keyboard panel to select the device ID (decoder, MVC and video wall controller).

Step 2 Press the *Num + SCENE* buttons on the keyboard panel to switch to the defined scene.

 NOTE

The scene of the video wall must be pre-configured for the decoder or MVC via client software.

WALL: 1
DEV: 1
SCENE: 2

Figure 3-4 Scene Calling

## 3.2 MAG by IP

The keyboard can connect with the matrix access gateway, and realize the video wall control, PTZ control, etc.

Step 1 Set the network parameters of the matrix access gateway via web browser. Refer to 2.5 *Matrix Access Gateway* for details.

Step 2 Enter the **MAG by IP** operation mode on the keyboard.

Step 3 Press the *Num + MON* buttons to select the display window for the output channel.

Step 4 Press the *Num + WIN* buttons to set the window to play the decoded video.

Step 5 Press the *Num + CAM* buttons to select the input channel group. You can press the *PREV/NEXT* buttons to switch to the previous or next camera ID.

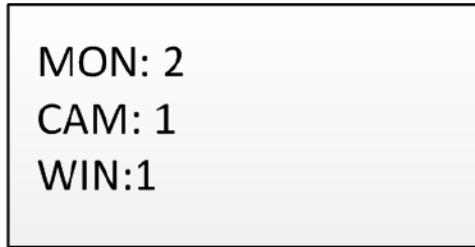

Figure 3-5 MAG by IP



**NOTE**

For the initial use of MAG, you must use the configuration kits software to configure the input/output channel ID of the MAG. Please see the related user manual for details. The input/output channel ID is used for switching on the video wall or PTZ control during keyboard operation.

Step 6 Operate the PTZ control on the video wall.

### 3.3 DVR by IP

The keyboard can connect with the DVR/NVR and remotely call the device menu and realize PTZ control through the virtual panel.

Step 1 Add NVR/DVR devices via web browser. Refer to *2.1.1 Add Devices* for details.

Step 2 Enter the **DVR by IP** operation mode on the keyboard.

Step 3 Press the *Num + DEV* buttons on the keyboard panel to select the device ID (viewed on the **Device Management > Device List > DVR/NVR**).

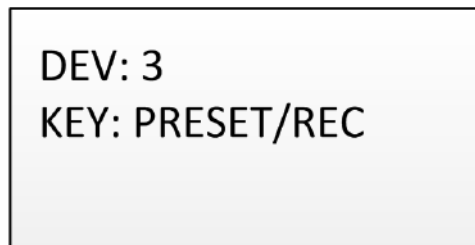

Figure 3-6 DVR by IP

Step 4 Operate the buttons on the keyboard panel to realize the corresponding functions. Refer to the Quick Start Guide to check the description of the DVR/NVR control buttons.

### 3.4 MAG by RS-422

The keyboard can connect with the matrix access gateway via RS-422 serial port, and realize the video wall control, PTZ control, etc.

**Before you start:**

Check the connection between the MAG and the keyboard. Connect the **T+** and **T-** terminals of the RS-422 serial port of the keyboard with that of the MAG.

See the following figure:

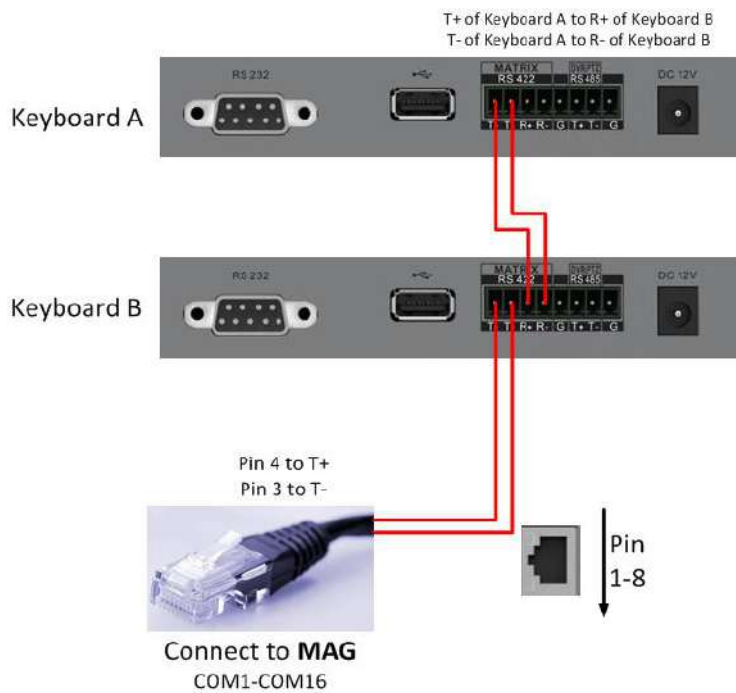

Figure 3-7 Connection between Cascaded Keyboards and MAG

See the following figure as an example for the network cable (568B). The pin 3 and pin 4 are colored in green-white and blue.

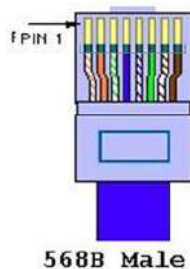

Figure 3-8 Network Cable

Step 1 Enter the **MAG by RS-422** operation mode on the keyboard.

Step 2 Press the *Num + MON* buttons to select the display window for the output channel.

Step 3 Press the *Num + WIN* buttons to set the window to play the decoded video.

Step 4 Press the *Num + CAM* buttons to select the input channel.

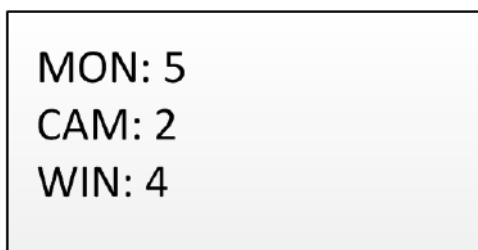

Figure 3-9 Matrix Operation

Step 5 You can operate the PTZ control on the video wall for the connected dome.



**NOTE**

- You can also press the *Num + CAM* buttons to select the input channel, and operate the PTZ control.
- For the initial use of MAG, you must use the configuration kits software to configure the input/output channel ID of the MAG. Please see the related user manual for details. The input/output channel ID is used for switching on the video wall or PTZ control during keyboard operation.

## 3.5 DVR by RS-485

---



**WARNING**

In DVR by RS-485 mode, the keyboard screen will display a prompt message asking you to confirm your device version. If your NVR is of a 4.1.50 or later version, select **Yes**; otherwise, select **No**. If your DVR is of a 3.5.35 or later version, select **Yes**; otherwise, select **No**. Please note that selecting an incorrect device version may result in function unavailability.

If you encounter a camera control problem, try to change the device ID of your NVR or DVR to a digit from 1 to 16.

---

The keyboard can connect with the DVR/NVR via RS-485 serial port, and remotely call the device menu and realize PTZ control through the virtual panel.

**Before you start:**

Check the connection between the DVR/NVR and the keyboard. Connect the **T+** and **T-** terminals of the RS-485 serial port of the keyboard with the KB port on the DVR/NVR rear panel respectively.



**NOTE**

Our keyboard products support DVR/NVR with KB ports only.



Figure 3-10 RS-485 Serial Port

Step 1 Enter the **DVR by RS-485** operation mode on the keyboard.

Step 2 Press the *Num + DEV* buttons on the keyboard panel to select the device ID (corresponding to the remote ID on ClientDemo).

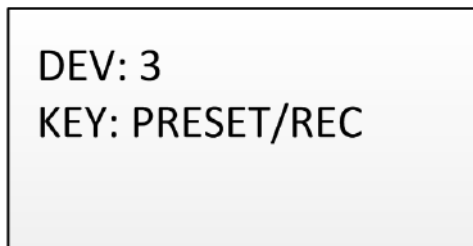

Figure 3-11 DVR by RS-485

Step 3 Move the joystick and operate the buttons on the keyboard panel to realize the corresponding functions. Refer to the Quick Start Guide to check the description of the DVR control buttons.

#### NOTE

The baud rate, protocol and other parameters of RS-485 of the keyboard must be configured to 9600, 8, 1, and none parity.

## 3.6 To Analog Device

### 3.6.1 Dome by RS-485

The keyboard can connect with the analog dome or PTZ unit via RS-485 serial port, and realize PTZ control.

#### ***Before you start:***

Check the connection between the dome and the Keyboard. Connect the **T+** and **T-** terminals of the keyboard's RS-485 serial port with the **RS485+** and **RS485-** terminals of the dome respectively.

Step 1 Enter the **To Analog Dev** operation mode on the keyboard.

Step 2 Press the *Num + CAM* buttons to select the dome site.

Step 3 Use the joystick and operate the buttons on the keyboard panel to realize the corresponding functions.





Figure 3-12 Dome by RS-485

**NOTE**

The address, baud rate, protocol, and other parameters of RS-485 must be configured the same with those of the dome.

### 3.6.2 Dome by RS-232

The keyboard can connect with the analog dome via RS-232 serial port, and control the dome via VISCA protocol.

Step 1 Connect the analog dome to the RS-232 serial port of the keyboard.



Figure 3-13 Analog Dome Connection

Step 2 Set the RS-232 parameters. You can set via both the local keyboard and the web browser. Select **Protocol** as **VISCA**. Refer to *2.4 Serial Port Settings* for details.

**NOTE**

The address, baud rate, protocol, and other parameters of RS-232 must be configured the same with those of the dome.

Step 3 Press **MODE** button on the keyboard, and select **To Analog Dev > RS232**.

Step 4 Press the *Num + CAM* buttons to select the dome site.

Step 5 Use the joystick and operate the buttons on the keyboard panel to realize the corresponding functions.

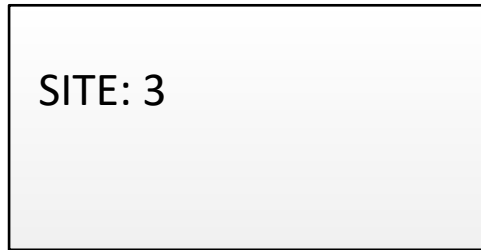

Figure 3-14 Dome by RS-232

### 3.6.3 Analog Matrix by RS-232

Step 1 Connect analog matrix to the RS-232 interface of the keyboard using RS-232 cable as shown below.



Figure 3-15 Analog Matrix RS-485 Connection

Step 2 Log in to the keyboard, select **Mode > To Analog Dev** and enter *Num + DEV*, *Num + MON* and *Num + CAM* to select the camera to control.

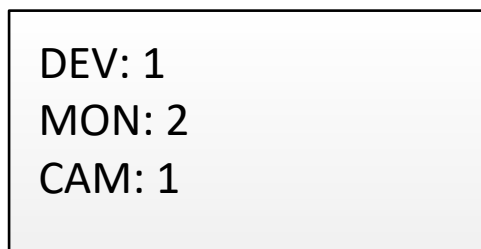

Figure 3-16 Analog Matrix By RS-485

## 3.7 Platform Access

### 3.7.1 Access to KPS by Network

Step 1 Set the network parameters of KPS via web browser. Refer to 2.6.1 *Connect to KPS* for details.

Step 2 Log in to KPS to view the MON ID and CAM ID.

Step 3 Log in to the keyboard, select **Mode > iVMS Platform** and enter *Num + WALL*, *Num + MON* and *Num + CAM*, or directly *Num + CAM* to select the camera to control.

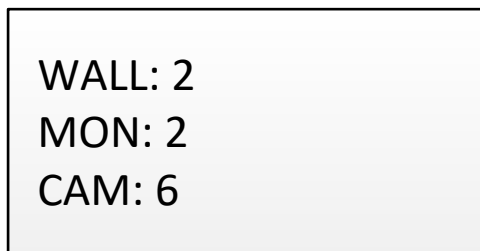

Figure 3-17 iVMS Platform Settings



- The parameters configurable through Web are also available when you log in to the keyboard and select **Mode > iVMS Platform**.
- Log in to the iVMS platform to check which device is corresponding to the number entered for MON and CAM. For details about the operations, see the related iVMS platform operation manual.

### 3.7.2 Access to Third-Party Platform by Network

Step 1 Set the network parameters of the third-party platform via web browser. Refer to 2.6.2 *Connect to Third-Party Platform* for details.

Step 2 Log in to the keyboard, select **Mode > Private VMS** and enter *Num + MON*, *Num + WIN* and *Num + CAM* to select the camera to control.

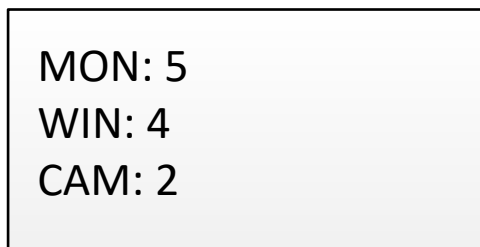

Figure 3-18 Private VMS Settings

**NOTE**

The parameters configurable through Web are also available when you log in to the keyboard and select **Mode > Private VMS**.

### 3.7.3 Access to HikCentral

Step 1 Set the network parameters of HikCentral via web browser. Refer to 2.6.3 *Connect to HikCentral* for details.

Step 2 Log in to HikCentral to view MON ID and CAM ID.

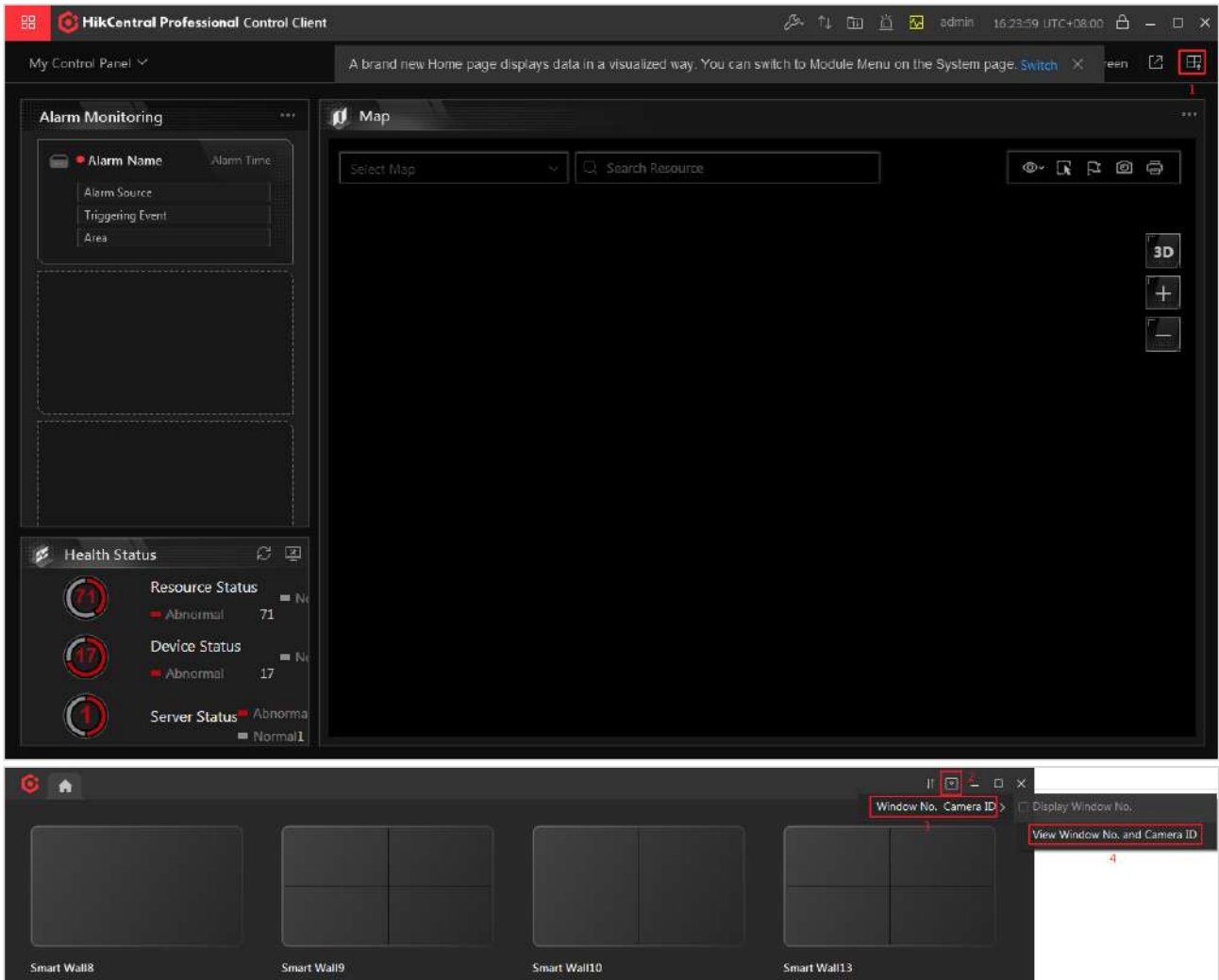

Figure 3-19 View Window No. and Camera ID via HikCentral

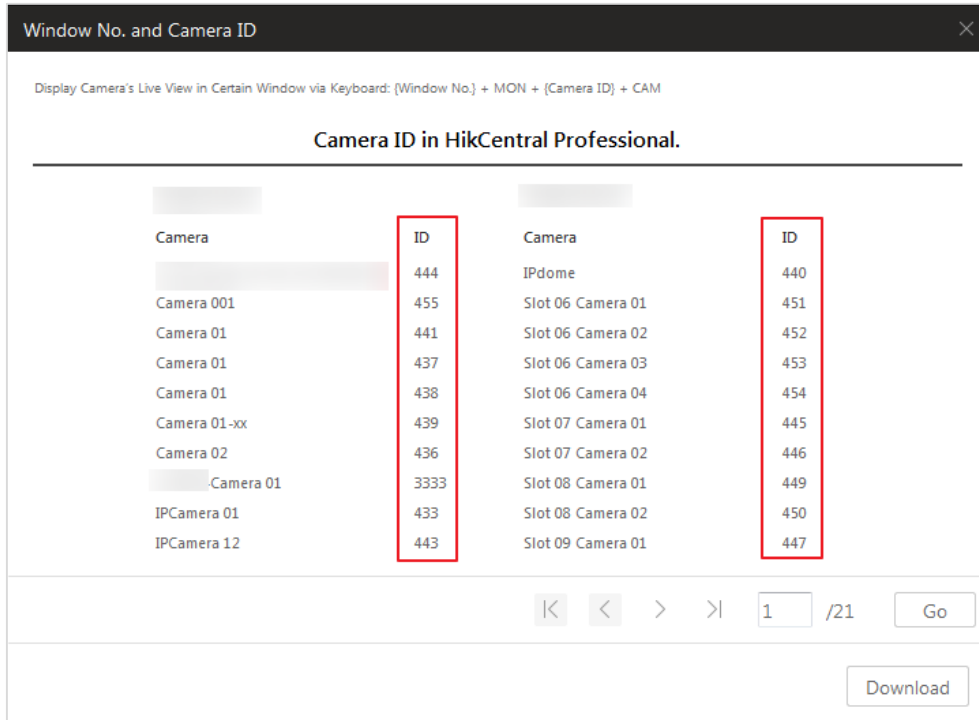

Figure 3-20 View CAM ID

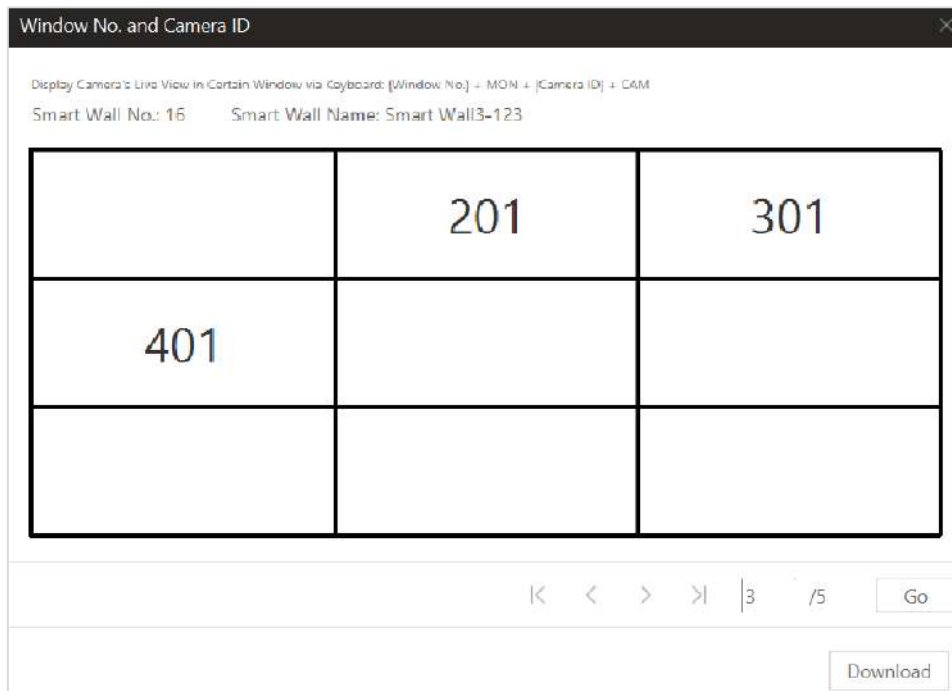

Figure 3-21 View MON ID

Step 3 Log in to the keyboard, and select **Mode > HikCentral**.

Step 4 Do the following operations.

- Switch video walls

Enter *Num + WALL (AUX)* to switch the video walls. You can press *WALL (AUX)* to view all the video walls.

- Select the output window (MON)

Enter *Num + MON* to select the output window. Enter *Num + MULT* to divide the window. Enter *Num + WIN* to select the sub-window (WIN) after dividing.

- Display on the video wall

Enter *Num + CAM* to select the camera to display on the video wall.

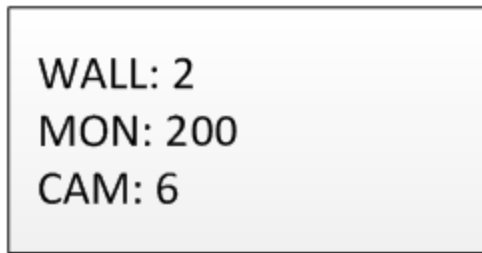

Figure 3-22 HikCentral Control

- Switch the previous/next camera

Press **PREV/NEXT** button to switch the previous or next camera.

- Tag the video

For the camera already displayed on the video wall and set recording schedule, press the top button on the joystick to tag the video.

- Control the camera directly

Exit from the video wall, and enter *Num + CAM* to control the camera independently.

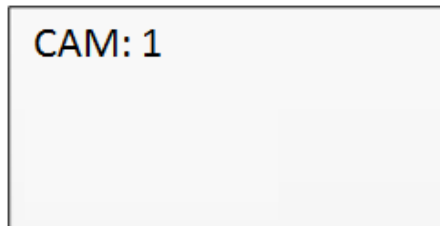

Figure 3-23 Control Camera Directly



Refer to the Quick Start Guide for the detailed descriptions of the functions of keyboard buttons.

## 3.8 Shortcut Operation

The device control via keyboard can be realized by shortcut operation.

Step 1 On the login interface, enter the user name and password to log in to the device.

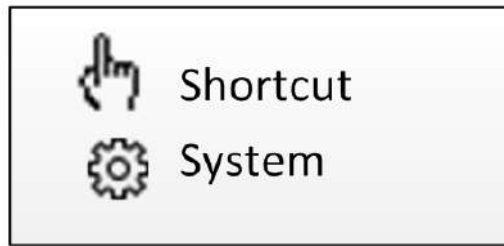

Figure 3-24 Menu

Step 2 Use the joystick to select the **Shortcut** to enter the shortcut operation mode.

Step 3 Press the *Num + DEV/MON/CAM/CAM-G/PRESET/PATROL/PATTERN/WIN/MULT/SCENE* on the keyboard buttons to realize the corresponding device operation and control.

## Chapter 4 System Menu Configuration

On the main menu after login, you can select **System** to check the version, and configure the system configuration, including network, user, RS-485, RS-422, hardware, time and maintenance.

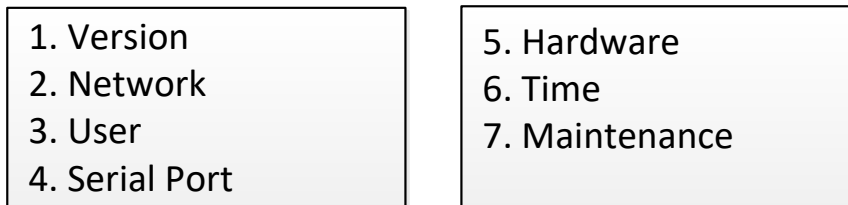

Figure 4-1 Main Menu

### 4.1 Version

Select **Version** to check the version information of the keyboard, including the firmware version, panel version, hardware version, core version, and serial No.

### 4.2 Network

#### 4.2.1 DHCP

If you enable **DHCP**, the device will automatically get the parameters such as the IP address, subnet mask, and gateway.

If you enable **DHCP**, you can set the IP address manually. Set **IP Address**, **Gateway**, and **Subnet Mask**.



Figure 4-2 DHCP

#### 4.2.2 SADP

If you enable SADP, the device can be searched via the SADP software in the same network segment. It is enabled by default.

#### 4.2.3 SSH

You are recommended to disable SSH service to guarantee the security.



## 4.3 User Management

Select **User** to enter the user management interface. You can change the password (admin), add new user, edit user or delete the user.

Click **OK** button or the central button of joystick to save the settings.

- 
- A rectangular menu box with a light gray background and a black border. It contains a numbered list of four options: 1. Change Pswd, 2. Add User, 3. Edit User, and 4. Delete User.
1. Change Pswd
  2. Add User
  3. Edit User
  4. Delete User

Figure 4-3 User Management



Only the admin user is allowed to add/edit/user the user (operator).

## 4.4 Serial Port Settings

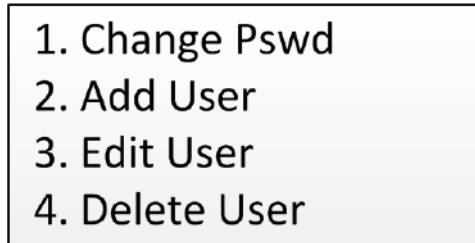
You can connect analog dome or DVR with the keyboard via RS-484 serial port, MVC/MAG via RS-422 serial port and analog matrix via RS-232 serial port.

Select **Serial Port** to enter the settings. You can configure the address bit (RS-485 only), baud rate, data bit, protocol, stop bit, parity, and copy all settings. When you set the Copy All to Yes for RS-485 serial port, the current settings will be copied to the connection of all other RS-485 devices.

Click the **OK** button or the central button of joystick to save the settings.

A screenshot of the RS-485 Settings interface, divided into two side-by-side boxes. The left box contains: Add. Bit: 0 (with '123' to its right), Baud Rate: 9600, Data Bit: 8, and PROT: PELCO-P. The right box contains: Stop Bit: 0, Parity: None, and Copy All: No.

Add. Bit: 0 <span style="float: right;">123</span>	Stop Bit: 0
Baud Rate: 9600	Parity: None
Data Bit: 8	Copy All: No
PROT: PELCO-P	

Figure 4-4 RS-485 Settings



The RS-485/RS-422/RS-232 parameters configured here must be the same with the connected dome/DVR or MAG.

## 4.5 Hardware

You can set the click sound, auto-logoff, and backlight feature of the keyboard.

Select **Hardware** to enter the following interface, and move (left/right) the joystick to set the function. Click **OK** button or the central button of joystick to save the settings.

If you enable **Click Sound**, there will be sound when you press the keyboard buttons. When the auto-logoff is set to ON, the system will automatically log off after the device is not operated for 30 minutes. The duration of backlight can be set as **Open** (always turned on), **5min**, **10min**, **30min**, and **60min**.

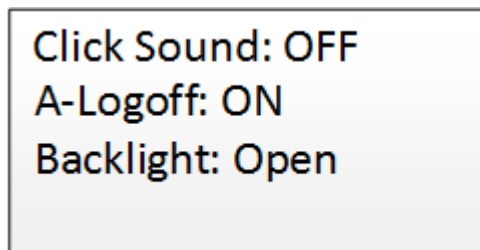

Figure 4-5 Hardware Settings

## 4.6 Time Settings

Select **Time** to enter the system time settings interface. You can set the value of year, month, date, time format, hour, minute and second. Click **OK** button or the central button of joystick to save the settings.

## 4.7 Maintenance

Select **Maintenance** to enter the system maintenance settings interface. You can upgrade the device, import and export the configuration files, and recover the device to the factory default settings.



Figure 4-6 Maintenance

 NOTE

- You should connect the U-flash disk to the keyboard before upgrading, and importing/exporting the files.
- The upgrade file and configuration file must be located in the root directory of the U-flash disk.
- The upgrade file must be in *digicap.dav*; and the configuration file in *kbCfg.bin*.



See Far, Go Further